

# IGBT Modules

## Sixpack

$I_{C80} = 440 \text{ A}$   
 $V_{CES} = 1200 \text{ V}$   
 $V_{CE(sat) \text{ typ.}} = 2.2 \text{ V}$

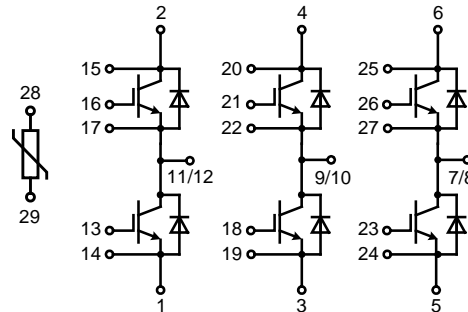

See outline drawing for pin arrangement

| IGBTs               |  |  |               |
|---------------------|--|--|---------------|
| Symbol              | Conditions   | Maximum Ratings                          |               |
| $V_{CES}$           | $T_{VJ} = 25^{\circ}\text{C to } 125^{\circ}\text{C}$  | 1200                                     | V             |
| $V_{GES}$           |  | $\pm 20$                                 | V             |
| $I_{C25}$           | $T_C = 25^{\circ}\text{C}$   | 640                                      | A             |
| $I_{C80}$           | $T_C = 80^{\circ}\text{C}$   | 440                                      | A             |
| <b>RBSOA</b>        | $R_G = 2.7 \Omega$ ; $T_{VJ} = 125^{\circ}\text{C}$<br>Clamped inductive load; $L = 100 \mu\text{H}$   | $I_{CM} = 900$<br>$V_{CEK} \leq V_{CES}$ | A             |
| $t_{SC}$<br>(SCSOA) | $V_{CE} = 900 \text{ V}$ ; $V_{GE} = \pm 15 \text{ V}$ ; $R_G = 2.7 \Omega$<br>$T_{VJ} = 125^{\circ}\text{C}$ ; non-repetitive; $V_{CEmax} \leq V_{CES}$ | 10                                       | $\mu\text{s}$ |
| $P_{tot}$           | $T_C = 25^{\circ}\text{C}$   | 2.2                                      | kW            |

### Features

- NPT<sup>3</sup> IGBT technology
- low saturation voltage
- low switching losses
- square RBSOA, no latch up
- high short circuit capability
- positive temperature coefficient for easy parallelling
- MOS input, voltage controlled
- ultra fast free wheeling diodes
- solderable pins for PCB mounting
- package with copper base plate

### Advantages

- space savings
- reduced protection circuits
- package designed for wave soldering

### Typical Applications

- AC motor control
- AC servo and robot drives
- power supplies

| Symbol        | Conditions   | Characteristic Values   |      |       |               |    |
|---------------|--|---|------|-------|---------------|----|
|               |  | $(T_{VJ} = 25^{\circ}\text{C}, \text{ unless otherwise specified})$ |      |       |               |    |
|               |  | min.  | typ. | max.  |               |    |
| $V_{CE(sat)}$ | $I_C = 450 \text{ A}$ ; $V_{GE} = 15 \text{ V}$  |   | 2.2  | 2.4   | V             |    |
|               |  |   | 2.5  |       | V             |    |
| $V_{GE(th)}$  | $I_C = 18 \text{ mA}$ ; $V_{GE} = V_{CE}$  | 4.5   |      | 6.5   | V             |    |
| $I_{CES}$     | $V_{CE} = V_{CES}$ ; $V_{GE} = 0 \text{ V}$  |   | 6    | 21    | mA            |    |
|               |  |   |      |       | mA            |    |
| $I_{GES}$     | $V_{CE} = 0 \text{ V}$ ; $V_{GE} = \pm 20 \text{ V}$   |   |      | 600   | nA            |    |
| $t_{d(on)}$   | Inductive load, $T_{VJ} = 125^{\circ}\text{C}$<br>$V_{CE} = 600 \text{ V}$ ; $I_C = 450 \text{ A}$<br>$V_{GE} = \pm 15 \text{ V}$ ; $R_G = 2.7 \Omega$ |   | 190  |       | ns            |    |
| $t_r$         |  |   | 116  |       | ns            |    |
| $t_{d(off)}$  |  |   | 475  |       | ns            |    |
| $t_f$         |  |   | 100  |       | ns            |    |
| $E_{on}$      |  |   |      | 35    |               | mJ |
| $E_{off}$     |  |   |      | 47    |               | mJ |
| $C_{ies}$     | $V_{CE} = 25 \text{ V}$ ; $V_{GE} = 0 \text{ V}$ ; $f = 1 \text{ MHz}$   |   | 33   |       | nF            |    |
| $Q_{Gon}$     | $V_{CE} = 600 \text{ V}$ ; $V_{GE} = 15 \text{ V}$ ; $I_C = 450 \text{ A}$   |   | 3.3  |       | $\mu\text{C}$ |    |
| $R_{thJC}$    |  |   |      | 0.057 | K/W           |    |

| <b>Diodes</b> |  |                        |                  |
|---------------|--|------------------------|------------------|
| <b>Symbol</b> | <b>Conditions</b>  | <b>Maximum Ratings</b> |                  |
| $I_{F80}$     | $T_C = 80^\circ\text{C}$   | 450                    | A                |
| $I_{FRM}$     | $t_p = 1 \text{ ms}$   | 900                    | A                |
| $I^2t$        | $T_{VJ} = 125^\circ\text{C}; t = 10 \text{ ms}; V_R = 0 \text{ V}$ | 35000                  | A <sup>2</sup> s |

| <b>Symbol</b>   | <b>Conditions</b>  | <b>Characteristic Values</b> |             |             |
|---|--|------------------------------|-------------|-------------|
| ( $T_{VJ} = 25^\circ\text{C}$ , unless otherwise specified) |  |                              |             |             |
|   |  | <b>min.</b>                  | <b>typ.</b> | <b>max.</b> |
| $V_F$   | $I_F = 450 \text{ A}; V_{GE} = 0 \text{ V}; T_{VJ} = 25^\circ\text{C}$                                       |                              |             | 2.2         |
| $I_{RM}$  | $I_F = 450 \text{ A}; di_F/dt = 3500 \text{ A}/\mu\text{s}; T_{VJ} = 125^\circ\text{C}; V_R = 800 \text{ V}$ |                              | 200         |             |
| $R_{thJC}$  |  |                              | 0.075       |             |

| <b>Temperature Sensor NTC</b> |                        |                              |             |             |
|-------------------------------|------------------------|------------------------------|-------------|-------------|
| <b>Symbol</b>                 | <b>Conditions</b>      | <b>Characteristic Values</b> |             |             |
|                               |                        | <b>min.</b>                  | <b>typ.</b> | <b>max.</b> |
| $R_{25}$                      | $T = 25^\circ\text{C}$ | 4.75                         | 5.0         | 5.25        |
| $B_{25/50}$                   |                        |                              | 3375        |             |

| <b>Module</b> |  |                        |                  |
|---------------|--|------------------------|------------------|
| <b>Symbol</b> | <b>Conditions</b>                              | <b>Maximum Ratings</b> |                  |
| $T_{VJ}$      | operating                                      | -40...+125             | $^\circ\text{C}$ |
| $T_{JM}$      |  | +150                   | $^\circ\text{C}$ |
| $T_{stg}$     |  | -40...+125             | $^\circ\text{C}$ |
| $V_{ISO}$     | $I_{ISOL} \leq 1 \text{ mA}; 50/60 \text{ Hz}$ | 3400                   | V~               |
| $M_d$         | Mounting torque (M5)                           | 3 - 6                  | Nm               |
|               | Terminal connection torque (M6)                | 3 - 6                  | Nm               |

| <b>Symbol</b>         | <b>Conditions</b>            | <b>Characteristic Values</b> |             |             |
|-----------------------|------------------------------|------------------------------|-------------|-------------|
|                       |                              | <b>min.</b>                  | <b>typ.</b> | <b>max.</b> |
| $R_{therm-chip}^{*)}$ | Resistance terminal to chip  |                              | 0.55        |             |
| $d_S$                 | Creepage distance on surface | 12.7                         |             |             |
| $d_A$                 | Strike distance in air       | 10                           |             |             |
| $R_{thCH}$            | with heatsink compound       |                              | 0.01        |             |
| <b>Weight</b>         |                              |                              | 900         |             |

\*)  $V = V_{CEsat} + 2x R_{therm-chip} \cdot I_C$  resp.  $V = V_F + 2x R \cdot I_F$

Dimensions in mm (1 mm = 0.0394")

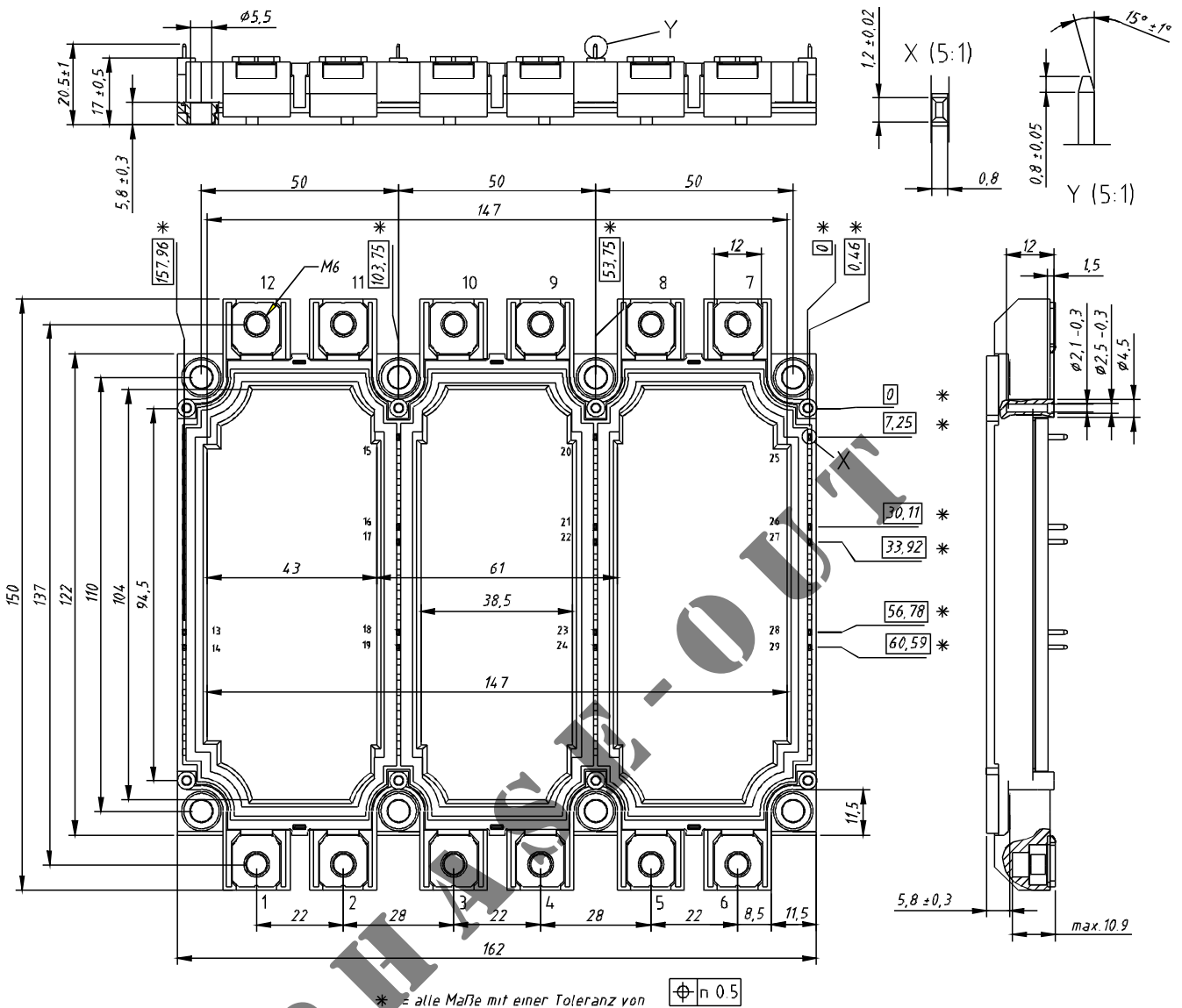

= tolerance for all dimensions:

| Diode                 |                   | IGBT                  |                   |
|-----------------------|-------------------|-----------------------|-------------------|
| $R_i$                 | $\tau_i$          | $R_i$                 | $\tau_i$          |
| $2.884 \cdot 10^{-5}$ | $1 \cdot 10^{-5}$ | $2.344 \cdot 10^{-5}$ | $1 \cdot 10^{-5}$ |
| $1.523 \cdot 10^{-3}$ | $5 \cdot 10^{-5}$ | $5.97 \cdot 10^{-4}$  | $5 \cdot 10^{-5}$ |
| $7.617 \cdot 10^{-3}$ | 0.012             | $5.97 \cdot 10^{-3}$  | 0.015             |
| 0.03                  | 0.078             | 0.023                 | 0.075             |
| 0.036                 | 0.82              | 0.028                 | 0.69              |

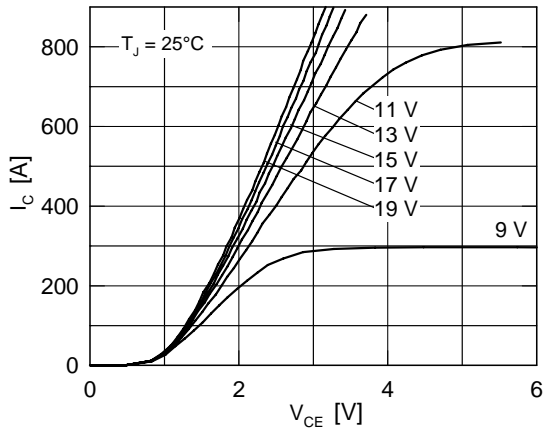

Fig. 1 Typ. output characteristics

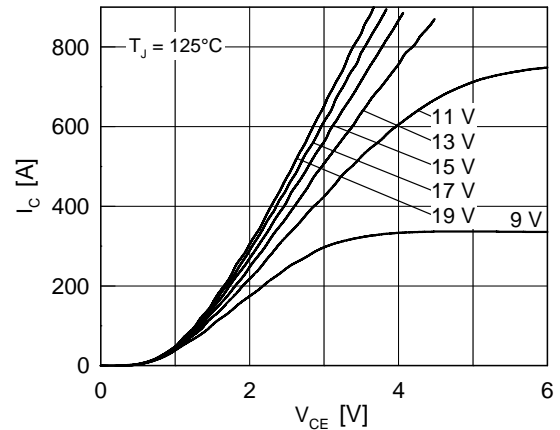

Fig. 2 Typ. output characteristics

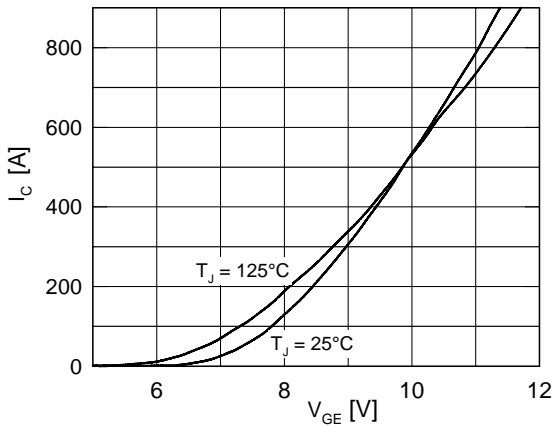

Fig. 3 Typ. transfer characteristics

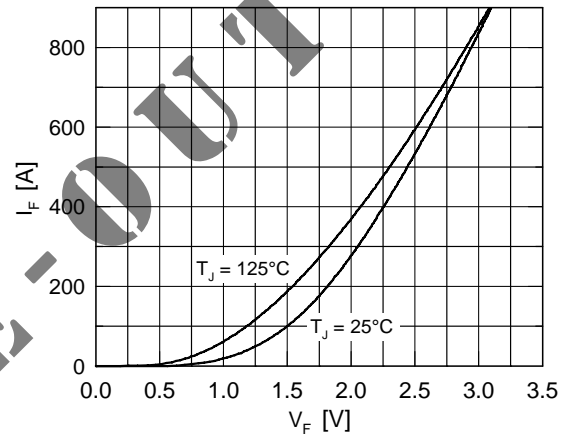

Fig. 4 Typ. forward characteristics of free wheeling diode

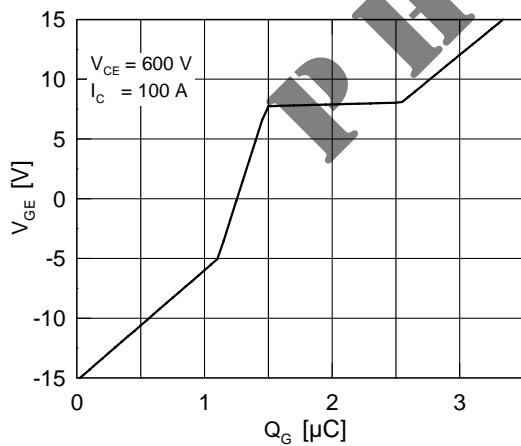

Fig. 5 Typ. turn on gate charge

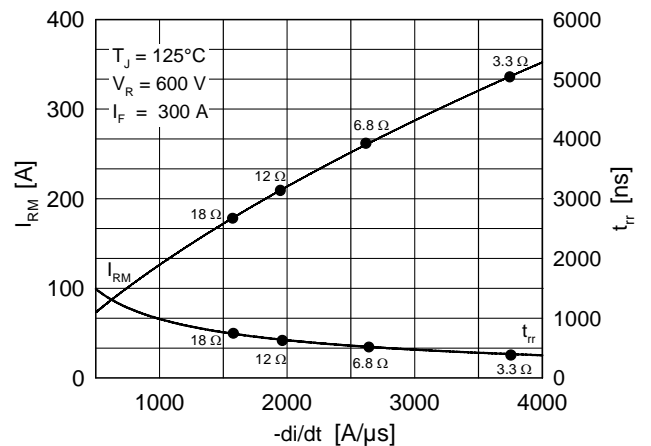

Fig. 6 Typ. turn off characteristics of free wheeling diode

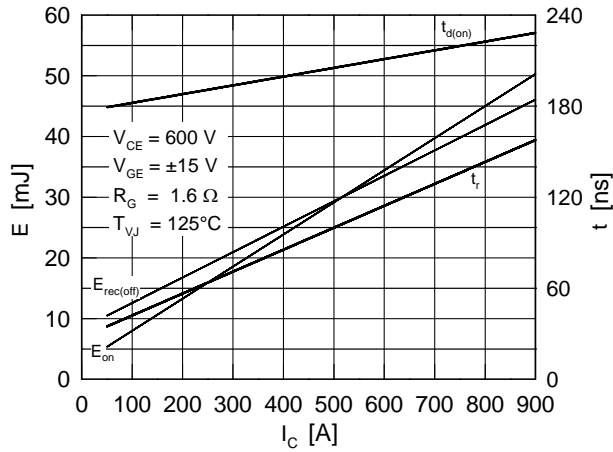

Fig. 7 Typ. turn on energy and switching times versus collector current

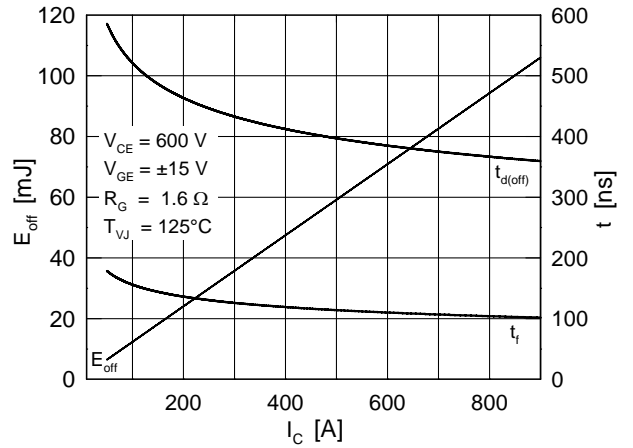

Fig. 8 Typ. turn off energy and switching times versus collector current

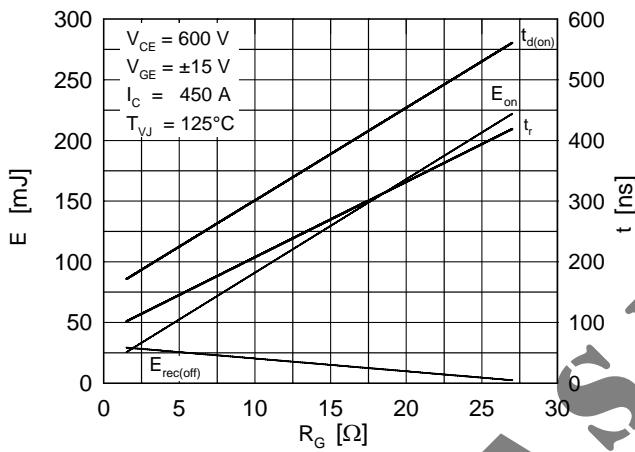

Fig. 9 Typ. turn on energy and switching times versus gate resistor

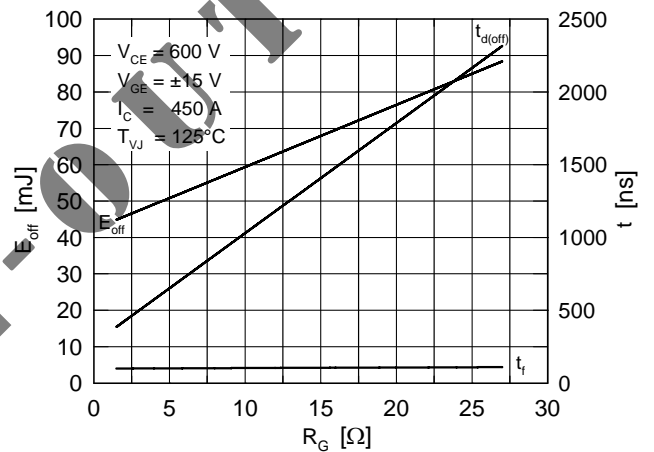

Fig. 10 Typ. turn off energy and switching times versus gate resistor

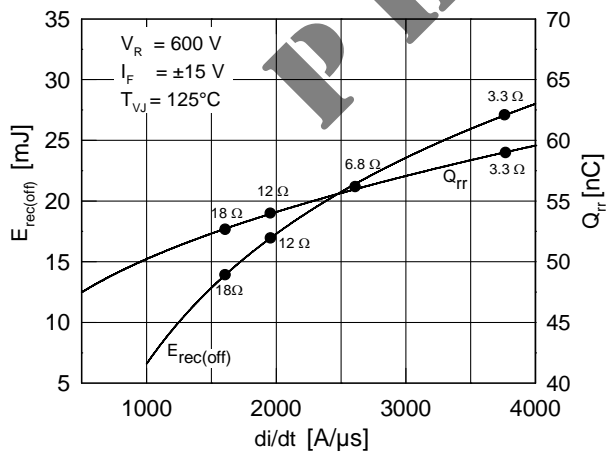

Fig. 11 Typ. turn off energy and recovered charge of free wheeling diode

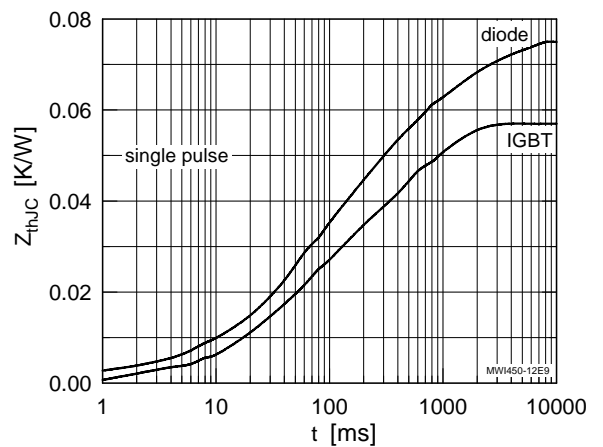

Fig. 12 Typ. transient thermal impedance