



LED55WPG Series – Programmable LED Driver

Dimmable Constant Current Driver

Set maximum current with software or Rset resistor

Electrical Specifications

Input Voltage Range:	120-277 Vac Nom. (108-305 V Min/Max)
Frequency:	50/60 Hz Nom. (47-63 Hz Min/Max)
Power Factor:	>0.90 @ full load, 120V through 277V
Inrush Current:	<30.0 Amps max @ 277 Vac
Input Current (Max):	0.56 Amps @ 120V, 60Hz 0.25 Amps @ 277V, 60Hz
Maximum Power:	55W
Line Regulation:	±2%
Load Regulation:	±3%
THD:	≤ 20% @ ≥ 60% full load
Ripple Current:	3% (Typ), 5% (Max)
Start-up Time:	500mS (typical)
Output Protection:	Over-Voltage, Short Circuit Protection with Auto Restart

Environmental Specifications

Maximum Case Temp.	80°C
Type TL Rating:	86°C/ 60°C
Minimum Starting Temp:	-30°C
Storage Temperature:	-40°C to +85°C
Humidity:	Up to 90% RH
Cooling:	Convection
Vibration Frequency:	5 to 55 Hz/2g, 30 minutes
Sound Rating:	Class A
Lifetime:	50,000 Hours, 67°C @ Tc point (see graph for details)
MTBF:	362,000 hours @ Full Load per MIL-217F Notice 2
EMC:	FCC 47CFR Part 15 Class A compliant



- Program driver with GUI software for fast setup
- Option to program output current with Rset resistor
- Linear or logarithmic dimming curve options
- Flicker free output for comfort and critical applications
- 2-stage power supply design for better performance over wide range of outputs
- Auxiliary 12Vdc, 200mA output for powering controls or fans
- NTC option allows for thermal protection of LED engine
- Adjustable Output Current: 100-1500mA
- UL Dry & Damp Location Rated, Class 2, Type TL
- Dim to zero with 0-10V dimming
- Metal housing

Constant Current - Product Specifications

Model Number	Output Current (mA ±5%)	Output Voltage (Vdc)	Max Output Power (W)	Type TL Rating	Typical Efficiency
LED55WPG1-055-C1500-D2	100-1500	12-55	55	86/60°C	88%

Class 2: US/Canada

Required Programming Tools

Model Number	Description
PG1-C3	TRP Programming Cord (3 ft. long); REQUIRED
PG1-SW	TRP Programming Software DOWNLOAD



Note:
LED drivers are designed and intended to operate LED loads only. Non-LED loading may be outside the specified design limits of our LED drivers, and therefore cannot be covered by any warranty. If you desire to use our LED drivers to operate non-LED loads please contact us to discuss compatibility.

Specifications subject to change without notice.

Rev 7-15-16



Dimensions - Inches (mm)

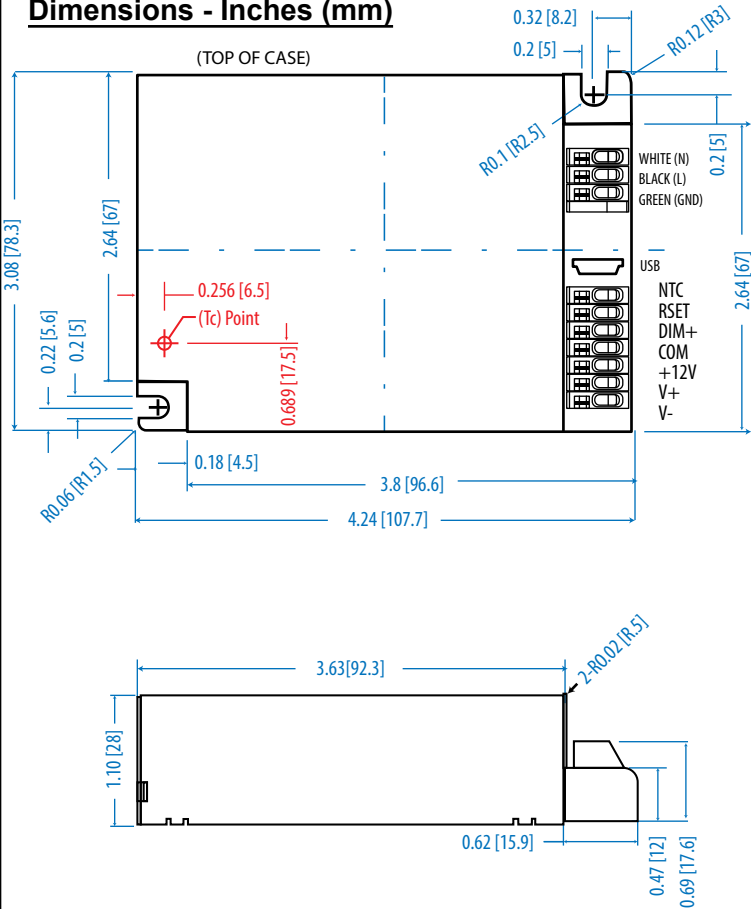

PUSH IN CONNECTORS

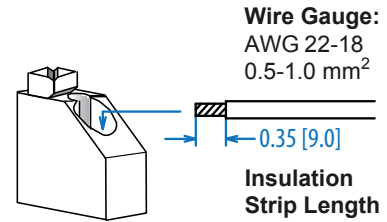

LED Light Engine Remote Mounting

Recommended maximum wiring distance at full load.

AWG	#22	#21	#20	#19	#18
Distance (m)	10	12	14	18	22
Distance (ft)	32.8	39.4	45.9	59	72.2

Wiring Connections

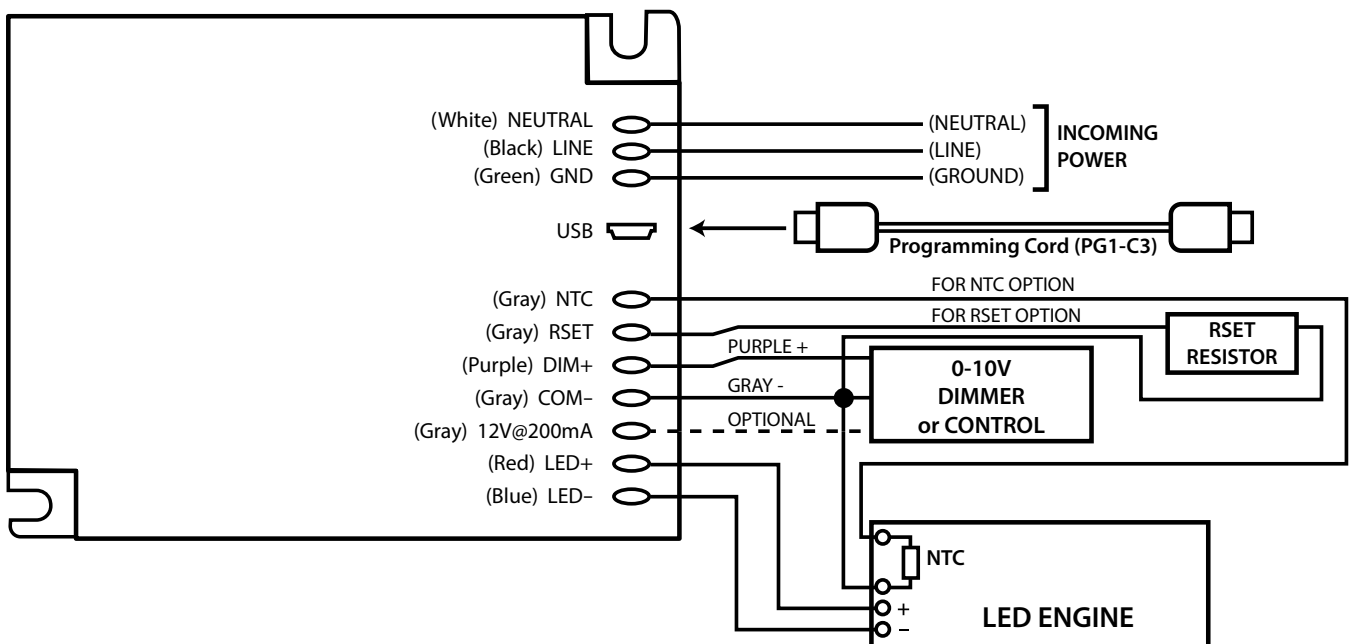

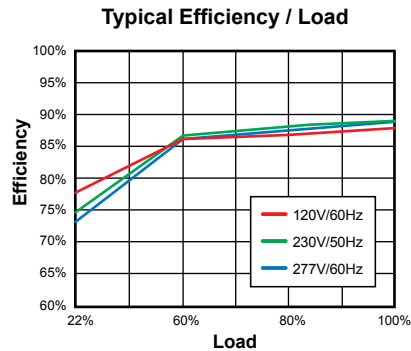
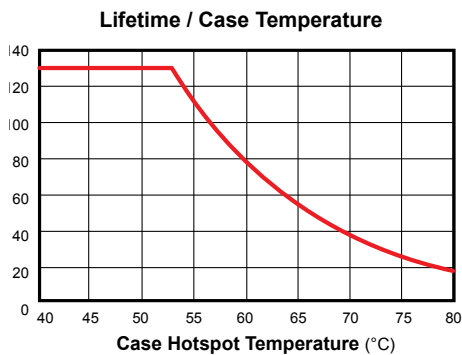
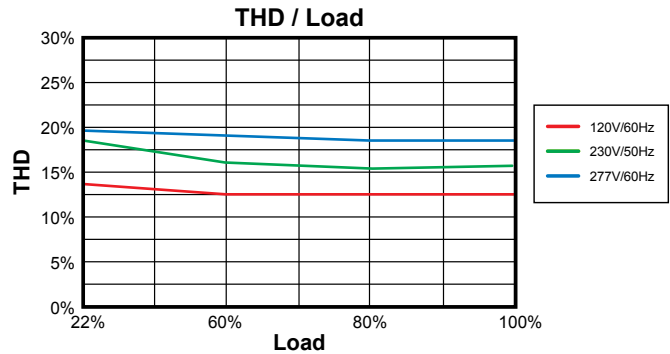
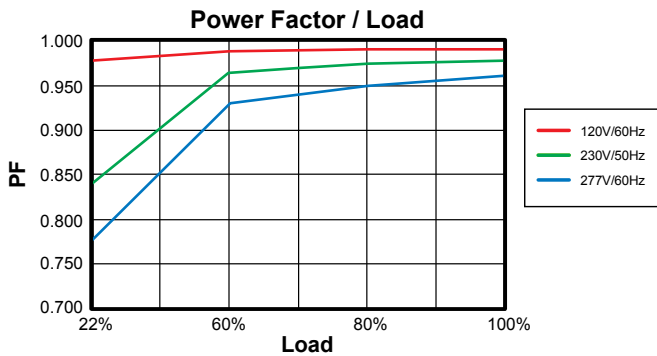

Note:
Disconnect input power to LED driver for at least 30 seconds before connecting or disconnecting Driver output and LED Engine. This prevents potential arcing transients that can damage the Engine and Driver. See Hot Plugging in our Driver Application Guide for more information.

0-10VDC Dimming

Parameters	Min	Typical	Max
12V Auxiliary Output	11V	12.0V	13.0V
12V Auxiliary Output Source Current	0mA	—	200mA
Absolute Voltage Range on 0-10V Input (Purple Wire)	-2.0 V	—	+15 V
Source Current out of 0-10V Input (Purple Wire)	0 mA	—	1.5 mA

Notes:

1. Single series strings of LEDs will perform best with deep dimming settings.
2. LEDs with parallel strings (discrete component or COB) may not perform well with deep dimming settings.
3. Specific LED and driver combinations must be tested to determine the lowest output setting for stable performance.

Safety Certification	Standard
UL/CUL	UL8750, UL1310 for UL Class 2 & CAN/CSA C22.2 No. 250.13, UL Type TL 86/60°C
CE	EN61347-1, EN61347-2-13
EMC Standard	Notes
FCC, 47CFR Part 15	Class A
EN 55015	Limits and methods of measurement of radio disturbance characteristics of electrical lighting and similar equipment.
EN 61000-3-2	Part 3-2: Limits for harmonic current emissions Class C, ≥80% Rated Power
EN 61000-3-3	Part 3-3: Limitation of voltage changes, voltage fluctuations and flicker.
EN 61000-4-5	Part 4-5: Surge Immunity test, 2 kV L-N, 4 kV L-FG & N-FG
Energy Star	Energy Star transient protection: Ballast or driver shall comply with ANSI/IEEE C62.41.1-2002 and ANSI/IEEE C62.41.2-2002, Category A operation. The line transient shall consist of seven strikes of a 100 kHz ring wave, 2.5 kV level, for both common mode and differential mode.

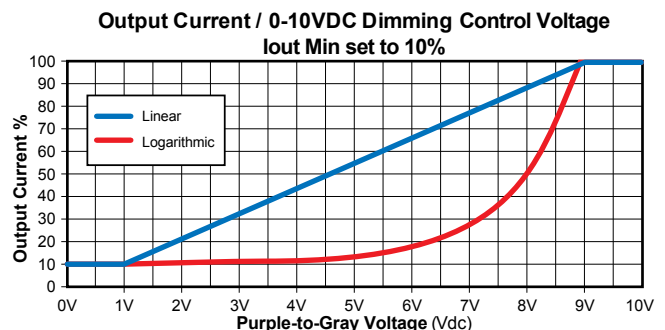
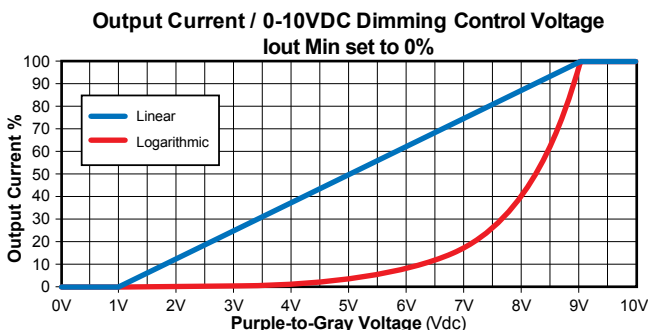

Typical Dimming Circuit: 2-Wire Resistance

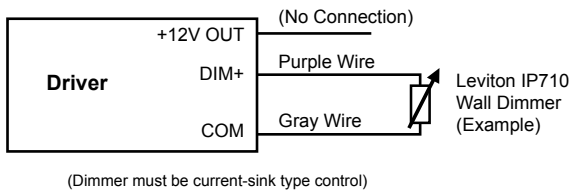

Typical Dimming Circuit: 2-Wire 0-10V Analog

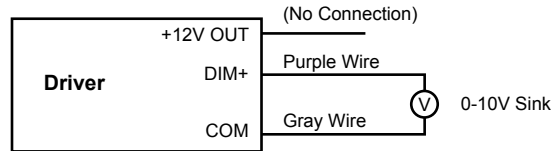

Typical Dimming Circuit: 3-Wire Resistance

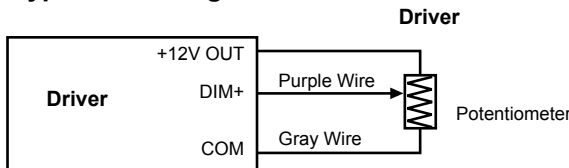

Typical Dimming Circuit: 12V Powered Control

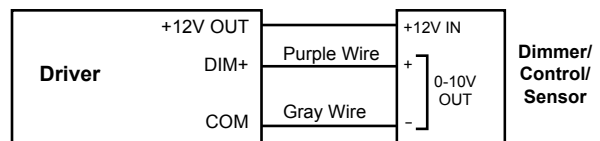

Notes:

1. Part comes with DIM+, COM & +12V auxiliary connectors. DIM+ and +12V return are connected to COM. This is for controls and sensors that need a 12V supply.
2. Part is compatible with most 0-10V Wall Slide dimmers and direct 0-10V analog signal. Recommended dimmer is Leviton IP710 or equivalent connected between Purple and COM wires.
3. Output current will be Minimum Programmed Value when $V_{dim} \leq 1.00V$. If set to 0% then this indicates dim to zero operation.
4. Output will be 100% with DIM+/COM open or above 9.0V and Minimum Programmed Value with DIM+/COM Shorted.
5. Minimum dimming level is programmable with TRP Programming software.

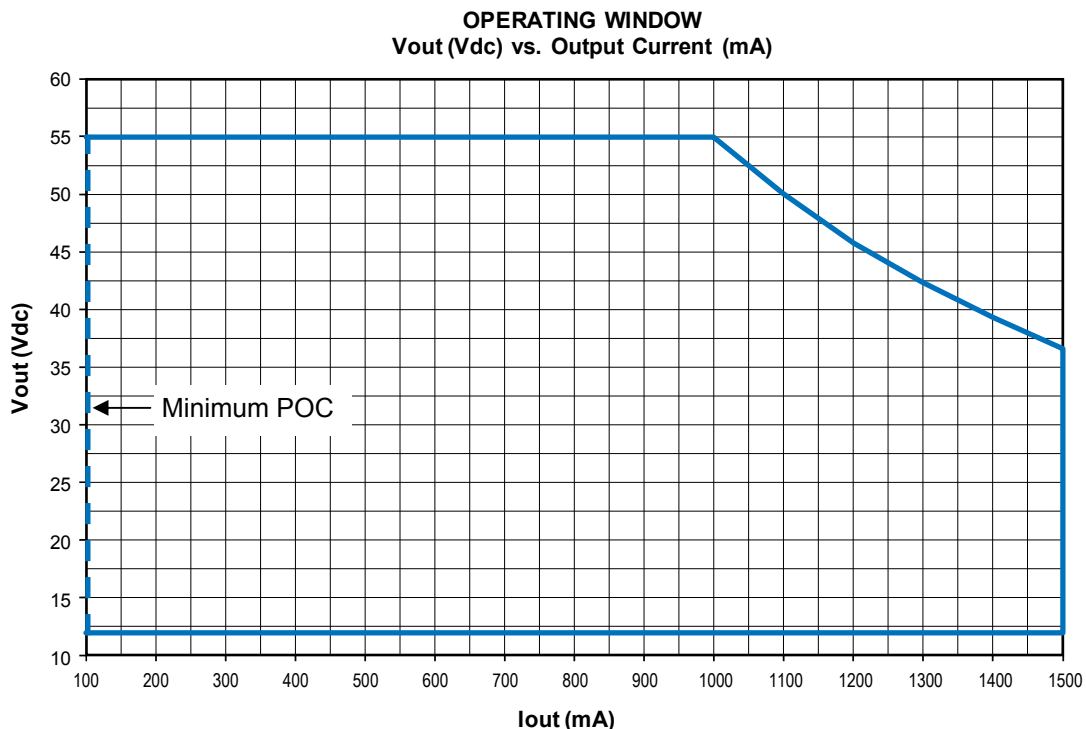

Programming The Driver Output

Select resistance (RSET) from the table for required output current (ILED). Connect as shown in the wiring diagram.

Rset Table (full range)

Rset (Ohms)	POC Iout (mA)	Rset (Ohms)	POC Iout (mA)	Rset (Ohms)	POC Iout (mA)	Rset (Ohms)	POC Iout (mA)	Rset (Ohms)	POC Iout (mA)	Rset (Ohms)	POC Iout (mA)	Rset (Ohms)	POC Iout (mA)
100	100.9	187	140.7	348	210.5	649	329.4	1210	518.8	2260	792.2	4870	1212.7
102	101.8	191	142.5	357	214.2	665	335.4	1240	528.0	2320	805.4	4990	1226.6
105	103.2	196	144.7	365	217.6	681	341.3	1270	537.0	2370	816.2	5110	1240.1
107	104.1	200	146.5	374	221.3	698	347.5	1300	545.9	2430	829.0	5230	1253.3
110	105.5	205	148.7	383	225.1	715	353.7	1330	554.8	2490	841.5	5360	1267.2
113	106.9	210	150.9	392	228.8	732	359.9	1370	566.5	2550	853.9	5490	1280.7
115	107.9	215	153.2	402	232.9	750	366.4	1400	575.2	2610	866.1	5620	1293.9
118	109.2	221	155.8	412	237.0	768	372.8	1430	583.7	2670	878.0	5760	1307.8
121	110.6	226	158.0	422	241.0	787	379.6	1470	595.1	2740	891.7	5900	1321.2
124	112.0	232	160.7	432	245.1	806	386.3	1500	603.4	2800	903.3	6040	1334.4
127	113.4	237	162.9	442	249.1	825	393.0	1540	614.5	2870	916.5	6190	1348.0
130	114.8	243	165.5	453	253.6	845	399.9	1580	625.4	2940	929.5	6340	1361.3
133	116.2	249	168.1	464	258.0	866	407.2	1620	636.2	3010	942.3	6490	1374.2
137	118.0	255	170.7	475	262.4	887	414.4	1650	644.2	3090	956.6	6650	1387.6
140	119.4	261	173.3	487	267.2	909	421.9	1690	654.8	3160	968.9	6810	1400.7
143	120.7	267	175.9	499	271.9	931	429.3	1740	667.8	3240	982.6	6980	1414.1
147	122.6	274	179.0	511	276.6	953	436.7	1780	678.1	3320	996.1	7150	1427.2
150	123.9	280	181.6	523	281.3	976	444.3	1820	688.2	3400	1009.4	7320	1439.8
154	125.8	287	184.6	536	286.4	1000	452.2	1870	700.7	3480	1022.3	7500	1452.8
158	127.6	294	187.6	549	291.4	1020	458.8	1910	710.6	3570	1036.6	7680	1465.5
162	129.4	301	190.6	562	296.5	1050	468.5	1960	722.8	3650	1049.1	7870	1478.4
165	130.8	309	194.0	576	301.8	1070	475.0	2000	732.4	3740	1062.8	8060	1490.9
169	132.6	316	197.0	590	307.2	1100	484.5	2050	744.3	3830	1076.2	8200	1500.0
174	134.8	324	200.4	604	312.5	1130	494.0	2100	755.9	3920	1089.3	10000	GUI SET
178	136.6	332	203.8	619	318.2	1150	500.3	2150	767.5	4640	1185.2		
182	138.4	340	207.1	634	323.8	1180	509.6	2210	781.1	4750	1198.5		

Reading Resistor Codes

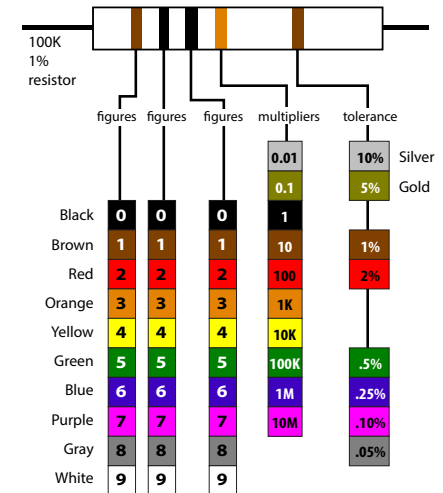

Rset Table

(nominal output currents)

Rset (Ω)	Iout (mA)
100	100
162	130
230	160
270	180
320	200
395	230
440	250
569	300
698	350
845	400
996	450
1150	500
1490	600
1870	700
2300	800
2800	900
3320	1000
3660	1050
5230	1250
5700	1300
6220	1350
6800	1400
7460	1450
8200	1500
9800	1500
10000	GUI SET

Output Current (mA) vs. Rset (Ohms)

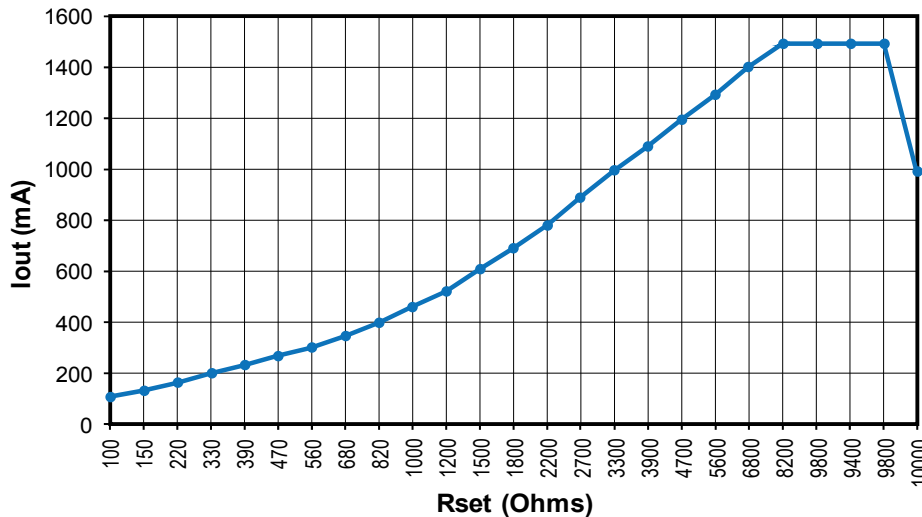

POC Setting: If Rset is open, TRP Programmer GUI can be used to set Iout.

Output Current vs. Rset or GUI value is within ±5%.

Rset can be any ≥1/4W, ±1%, ≥20V rated resistor.

***Rset >9,900 Ohms will default Iout to GUI setting.**

Notes:

1. Minimum wattage resistor rating is 1/4W leaded.
2. Larger wattages can be used for easy installation.
3. RSET best placed in LED engine to avoid field replacement programmability issues.
4. If RSET is placed on LED engine, SMD 0805 size is recommended.

Module Temperature Protection using External NTC (Negative Temperature Coefficient)

NTC

Select a Negative Thermal Coefficient (NTC) resistor with a resistance range that allows the full output current to flow at safe LED operating temperatures.

NTC resistance should drop sufficiently to allow reduced output current at elevated or harmful LED temperature levels.

NTC operation should be thoroughly tested to ensure proper operation over all the full temperature range of the Driver and the LED Engine.

Example: NTC High, NTC Low and NTC Minimum Iout% can be programmed using TRP Programmer USB interface & TRP PC based GUI Software.

Factory Default Settings: NTC Low = 2.0K \approx 10% Iout, NTC High = 6.3K, 100% Iout

Programmable settings: NTC Minimum Level (%), NTC Minimum Ohms, NTC Maximum Ohms.

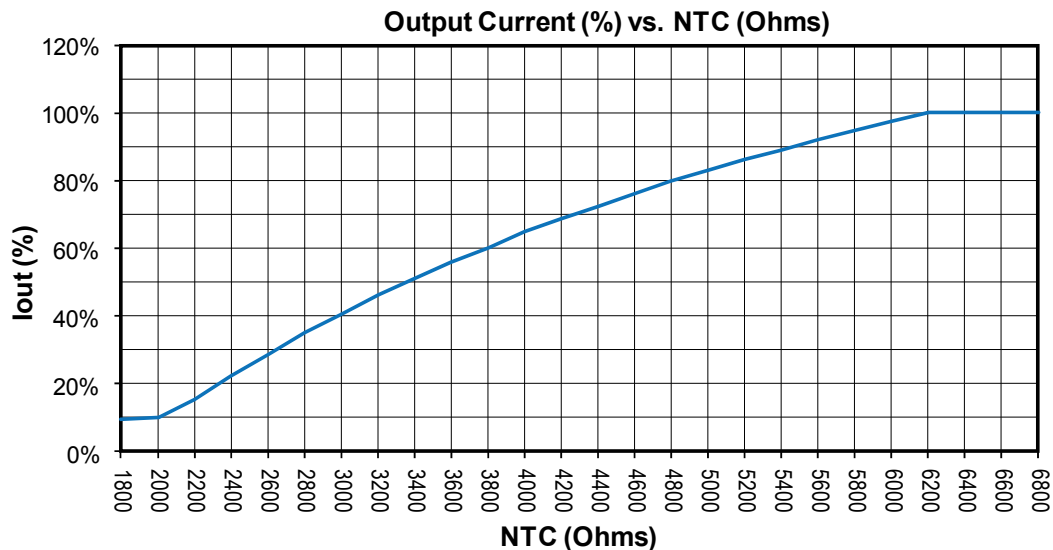

Module Temperature Protection Example

NTC = 805SMD, $R_{25C} = 15K \text{ Ohm} \pm 2\%$, $R_{64C} = 3700$, Vishay Part #: NTCS0805E3153GMT

With part set: NTC Max = 6.3K, NTC MIN = 2.0K, Iout Min = 10%

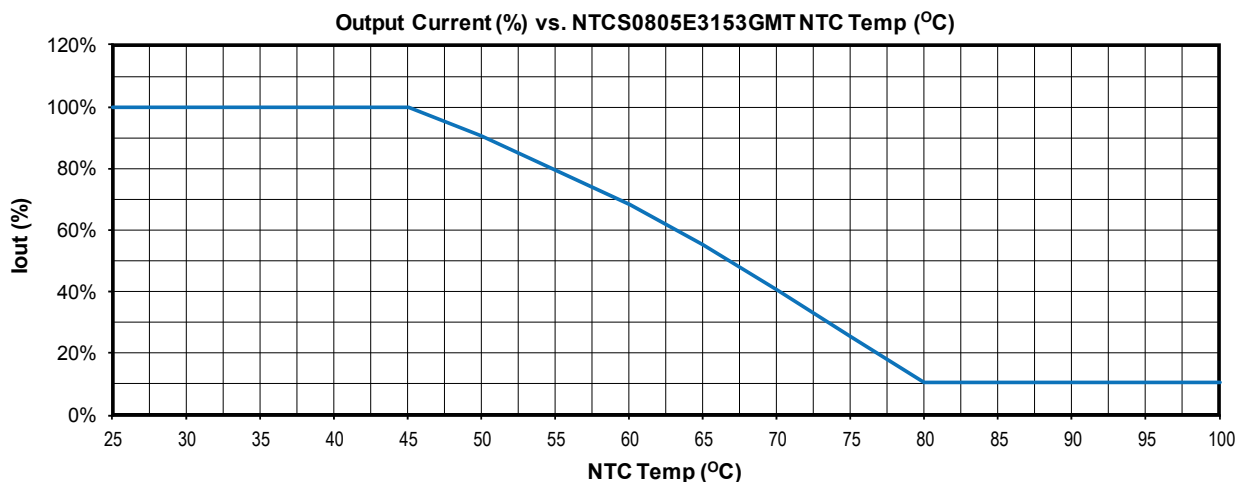



Programming TRP Drivers

Programmable Output Current (POC): Programmable Iout from 100mA to 1500mA

Programmable NTC settings: NTC Minimum Level (%), NTC Minimum Ohms, NTC Maximum Ohms.

Factory Default: NTC Minimum = 2.0K, ~ 10% Iout, NTC Maximum = 6.3K, 100% Iout

Programmable dimming curve: Linear or LOG Factory Default: Linear Dimming Curve

Programmable Minimum Dim Level: 0% (OFF) to 100% Iout programmed value. Factory Default: Min dim level 0%

TRP Programming Tools:

The TRP programming tools consists of programming software along with a special programming cord connected between the USB port of a computer and the TRP programmable LED driver being configured. The TRP programming software is a Windows PC based graphical user interface (GUI) that allows the user to program and configure the operating parameters of a TRP programmable LED driver. This interface allows the operator to set the LED drivers output current within its specified range. It also provides the ability to enable/disable and control features like "Dimming", "Auxiliary Output", "NTC Thermal Protection", "Constant Lumen Module", & "End-of-life indicator" when available in the LED driver being programmed.

Programming Cord (PG1-C3):

This is a specially designed cord adapter with USB connectors for linking the computer and the LED driver being programmed. This unit also provides all power required to the LED driver being programmed. A standard USB cable can be used to extend the length of the Programming Cord from the computer USB port. The micro-USB connector on the Programming Cord must be connected directly to the TRP Programmable Drive.

Programming Software (PG1-SW):

The programmer software is the windows based GUI that allows the user to assign custom part number(s) to the LED driver being programmed. The user can then save the driver profile to an external file and recall as needed. The "Auto Program" feature allows many LED drivers to be programmed to the same stored profile. This can be done by plugging the cord to each driver and a single click of the mouse. The programmer software supports bar code scanners. The barcode scanner can be used to automate the programming of the attached LED driver. This barcode scanner interface also provides an option to either enable or disable logging of the parameters to an Excel file.

Notes:

- Download the PG1-SW software from the TRP website: http://trpssl.com/driver_downloads.html
- The programming of the LED driver does not require the input be connected to an AC power connection. The TRP Programming Tool and the required LED driver circuitry will be powered from the programmer module via the USB connection to a computer.
- For new GUI settings to take effect the AC input must be cycled off/on and the USB interface disconnected.

Labeling Programmable Drivers:

It is highly recommended that the drivers be labeled with information traceable to the programming profile. It can include the programmed output current, dimming curve type, minimum dimming level and name of the file storing the profile. ***This information is critical to answering any field questions from the contractor or end user.***

Programmable Parameters						
Programmable Parameter	Programmable Minimum Value	Programmable Maximum Value	Factory Default	GUI Programmable	RSET Programmable	
Output Constant Current (Iout)	100 mA	1500 mA	1000 mA	YES	YES	
Disable Dimming?	NO	YES	NO	YES	N/A	
Dimming Curve	LINEAR	0%	N/A Fixed 100%	0%	YES	N/A
	LOG	0%	N/A Fixed 100%	0%	YES	N/A
NTC Minimum Ohms	1K Ω	10K Ω	2K Ω	YES	N/A	
NTC Minimum %Iout	~0%	100%	~10%	YES	N/A	
NTC Maximum Ohms	2K Ω	10K Ω	6.3K Ω	YES	N/A	

