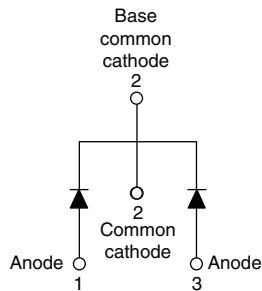

## HEXFRED® Ultrafast Soft Recovery Diode, 2 x 15 A

**TO-220AB**

**FEATURES**

- Ultrafast and ultrasoft recovery
- Very low  $I_{RRM}$  and  $Q_{rr}$
- AEC-Q101 qualified, meets JESD 201 class 1A whisker test
- Material categorization:  
for definitions of compliance please see [www.vishay.com/doc?99912](http://www.vishay.com/doc?99912)

**BENEFITS**

- Reduced RFI and EMI
- Reduced power loss in diode and switching transistor
- Higher frequency operation
- Reduced snubbing
- Reduced parts count

**DESCRIPTION**

VS-HFA30TA60CHN3 is a state of the art center tap ultrafast recovery diode. Employing the latest in epitaxial construction and advanced processing techniques it features a superb combination of characteristics which result in performance which is unsurpassed by any rectifier previously available. With basic ratings of 600 V and 15 A per leg continuous current, the VS-HFA30TA60CHN3 is especially well suited for use as the companion diode for IGBTs and MOSFETs. In addition to ultrafast recovery time, the HEXFRED® product line features extremely low values of peak recovery current ( $I_{RRM}$ ) and does not exhibit any tendency to “snap-off” during the  $t_b$  portion of recovery. The HEXFRED features combine to offer designers a rectifier with lower noise and significantly lower switching losses in both the diode and the switching transistor. These HEXFRED advantages can help to significantly reduce snubbing, component count and heatsink sizes. The HEXFRED VS-HFA30TA60CHN3 is ideally suited for applications in power supplies and power conversion systems (such as inverters), motor drives, and many other similar applications where high speed, high efficiency is needed.

PRODUCT SUMMARY	
Package	TO-220AB
$I_{F(AV)}$	2 x 15 A
$V_R$	600 V
$V_F$ at $I_F$	1.2 V
$t_{rr}$ typ.	19 ns
$T_J$ max.	150 °C
Diode variation	Common cathode

ABSOLUTE MAXIMUM RATINGS				
PARAMETER	SYMBOL	TEST CONDITIONS	VALUES	UNITS
Cathode to anode voltage	$V_R$		600	V
Maximum continuous forward current	$I_F$	$T_C = 100\text{ °C}$	15	A
per leg			30	
per device				
Single pulse forward current	$I_{FSM}$		150	
Maximum repetitive forward current	$I_{FRM}$		60	
Maximum power dissipation	$P_D$	$T_C = 25\text{ °C}$	74	W
		$T_C = 100\text{ °C}$	29	
Operating junction and storage temperature range	$T_J, T_{Stg}$		-55 to +150	°C



<b>ELECTRICAL SPECIFICATIONS PER LEG</b> ( $T_J = 25\text{ }^\circ\text{C}$ unless otherwise specified)						
PARAMETER	SYMBOL	TEST CONDITIONS	MIN.	TYP.	MAX.	UNITS
Cathode to anode breakdown voltage	$V_{BR}$	$I_R = 100\text{ }\mu\text{A}$	600	-	-	V
Maximum forward voltage	$V_{FM}$	$I_F = 15\text{ A}$	-	1.3	1.7	
		$I_F = 30\text{ A}$	-	1.5	2.0	
		$I_F = 15\text{ A}, T_J = 125\text{ }^\circ\text{C}$	-	1.2	1.6	
Maximum reverse leakage current	$I_{RM}$	$V_R = V_R$ rated	-	1.0	10	$\mu\text{A}$
		$T_J = 125\text{ }^\circ\text{C}, V_R = 0.8 \times V_R$ rated	-	400	1000	
Junction capacitance	$C_T$	$V_R = 200\text{ V}$	-	25	50	pF
Series inductance	$L_S$	Measured lead to lead 5 mm from package body	-	8	-	nH

<b>DYNAMIC RECOVERY CHARACTERISTICS PER LEG</b> ( $T_J = 25\text{ }^\circ\text{C}$ unless otherwise specified)						
PARAMETER	SYMBOL	TEST CONDITIONS	MIN.	TYP.	MAX.	UNITS
Reverse recovery time See fig. 5 and 10	$t_{rr}$	$I_F = 1.0\text{ A}, di_F/dt = 200\text{ A}/\mu\text{s}, V_R = 30\text{ V}$	-	19	-	ns
	$t_{rr1}$	$T_J = 25\text{ }^\circ\text{C}$	-	42	60	
	$t_{rr2}$	$T_J = 125\text{ }^\circ\text{C}$	-	70	120	
Peak recovery current See fig. 6	$I_{RRM1}$	$T_J = 25\text{ }^\circ\text{C}$	-	4.0	6.0	A
	$I_{RRM2}$	$T_J = 125\text{ }^\circ\text{C}$	-	6.5	10	
Reverse recovery charge See fig. 7	$Q_{rr1}$	$T_J = 25\text{ }^\circ\text{C}$	-	80	180	nC
	$Q_{rr2}$	$T_J = 125\text{ }^\circ\text{C}$	-	220	600	
Peak rate of fall of recovery current during $t_b$ See fig. 8	$di_{(rec)M}/dt1$	$T_J = 25\text{ }^\circ\text{C}$	-	250	-	A/ $\mu\text{s}$
	$di_{(rec)M}/dt2$	$T_J = 125\text{ }^\circ\text{C}$	-	160	-	

<b>THERMAL - MECHANICAL SPECIFICATIONS PER LEG</b>						
PARAMETER	SYMBOL	TEST CONDITIONS	MIN.	TYP.	MAX.	UNITS
Lead temperature	$T_{lead}$	0.063" from case (1.6 mm) for 10 s	-	-	300	$^\circ\text{C}$
Junction to case, single leg conducting	$R_{thJC}$				1.7	K/W
Junction to case, both legs conducting			-	-	0.85	
Thermal resistance, junction to ambient	$R_{thJA}$	Typical socket mount	-	-	40	
Thermal resistance, case to heatsink	$R_{thCS}$	Mounting surface, flat, smooth and greased	-	0.25	-	
Weight			-	6.0	-	
			-	0.21	-	oz.
Mounting torque			6.0 (5.0)	-	12 (10)	kgf · cm (lbf · in)
Marking device		Case style TO-220AB	HFA30TA60CH			

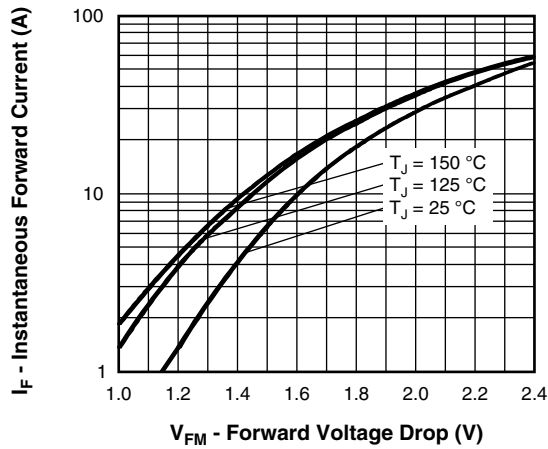

Fig. 1 - Maximum Forward Voltage Drop vs. Instantaneous Forward Current (Per Leg)

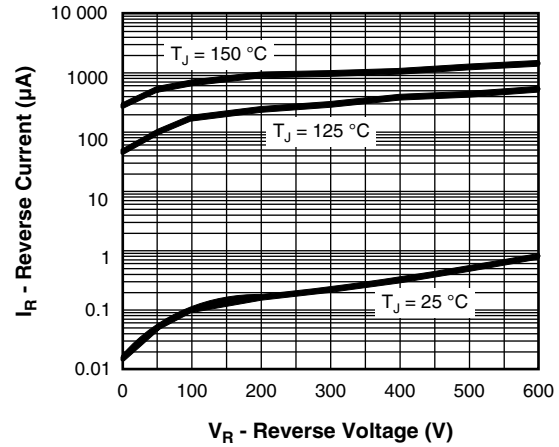

Fig. 2 - Typical Reverse Current vs. Reverse Voltage (Per Leg)

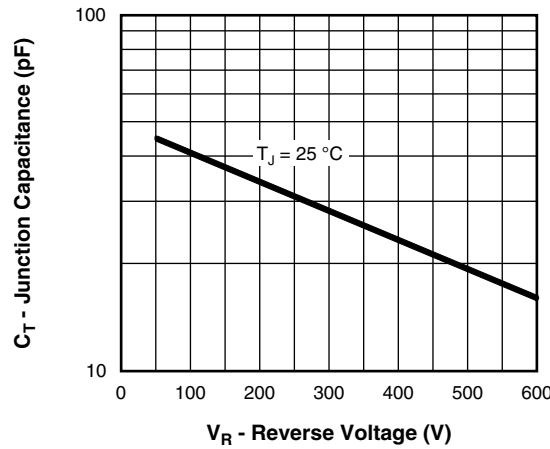

Fig. 3 - Typical Junction Capacitance vs. Reverse Voltage (Per Leg)

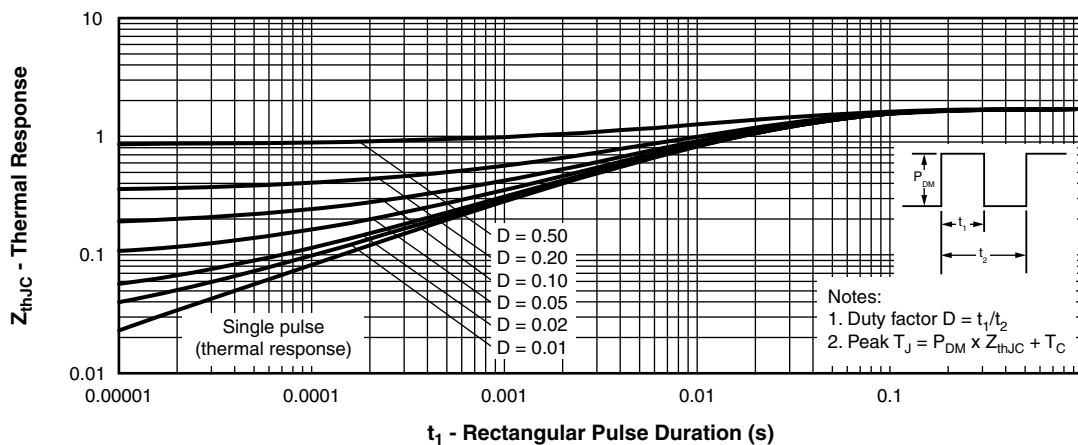

Fig. 4 - Maximum Thermal Impedance  $Z_{thJC}$  Characteristics (Per Leg)

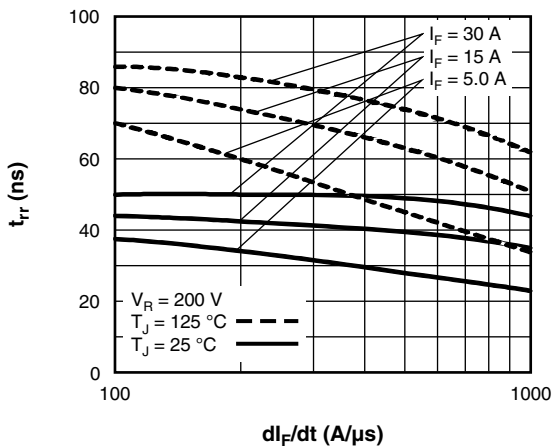

Fig. 5 - Typical Reverse Recovery Time vs.  $di_F/dt$  (Per Leg)

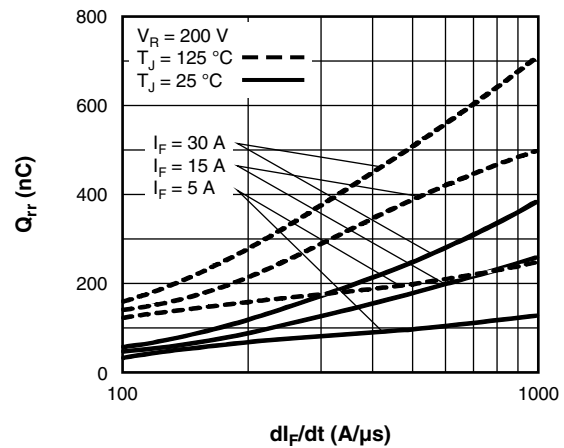

Fig. 7 - Typical Stored Charge vs.  $di_F/dt$  (Per Leg)

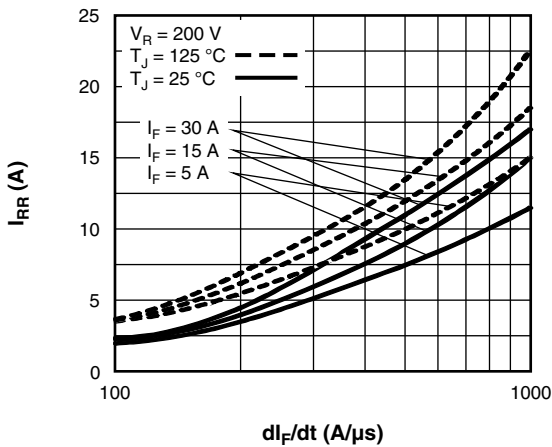

Fig. 6 - Typical Recovery Current vs.  $di_F/dt$  (Per Leg)

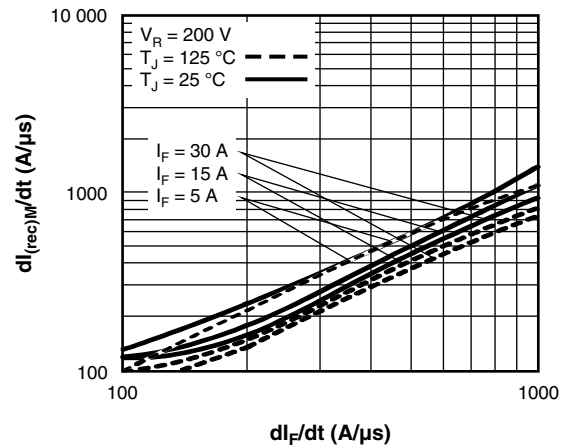

Fig. 8 - Typical  $di_{(rec)M}/dt$  vs.  $di_F/dt$  (Per Leg)

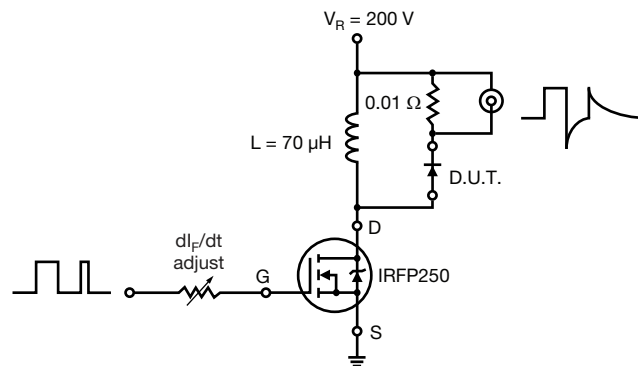
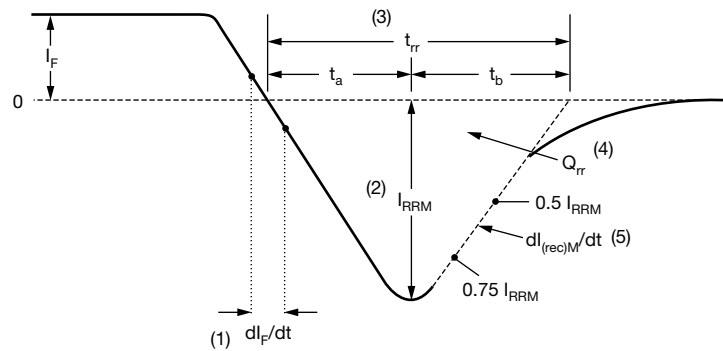

Fig. 9 - Reverse Recovery Parameter Test Circuit



- (1)  $dl_F/dt$  - rate of change of current through zero crossing
- (2)  $I_{RRM}$  - peak reverse recovery current
- (3)  $t_{rr}$  - reverse recovery time measured from zero crossing point of negative going  $I_F$  to point where a line passing through  $0.75 I_{RRM}$  and  $0.50 I_{RRM}$  extrapolated to zero current.
- (4)  $Q_{rr}$  - area under curve defined by  $t_{rr}$  and  $I_{RRM}$
- $$Q_{rr} = \frac{t_{rr} \times I_{RRM}}{2}$$
- (5)  $dl_{(rec)M}/dt$  - peak rate of change of current during  $t_b$  portion of  $t_{rr}$

Fig. 10 - Reverse Recovery Waveform and Definitions

**ORDERING INFORMATION TABLE**

Device code	<b>VS-</b>	<b>HF</b>	<b>A</b>	<b>30</b>	<b>TA</b>	<b>60</b>	<b>C</b>	<b>H</b>	<b>N3</b>
	①	②	③	④	⑤	⑥	⑦	⑧	⑨

- 1** - Vishay Semiconductors product
- 2** - HEXFRED® family
- 3** - Electron irradiated
- 4** - Current rating (30 = 30 A)
- 5** - Package:  
TA = TO-220AB
- 6** - Voltage rating (60 = 600 V)
- 7** - Circuit configuration:  
C = common cathode
- 8** - H = AEC-Q101 qualified
- 9** - Environmental digit:  
N3 = halogen-free, RoHS-compliant, and totally lead (Pb)-free

<b>ORDERING INFORMATION</b> (Example)			
PREFERRED P/N	QUANTITY PER T/R	MINIMUM ORDER QUANTITY	PACKAGING DESCRIPTION
VS-HFA30TA60CHN3	25	500	Antistatic plastic tube

<b>LINKS TO RELATED DOCUMENTS</b>	
Dimensions	<a href="http://www.vishay.com/doc?95222">www.vishay.com/doc?95222</a>
Part marking information	TO-220AB-N3 <a href="http://www.vishay.com/doc?95028">www.vishay.com/doc?95028</a>



## **Disclaimer**

ALL PRODUCT, PRODUCT SPECIFICATIONS AND DATA ARE SUBJECT TO CHANGE WITHOUT NOTICE TO IMPROVE RELIABILITY, FUNCTION OR DESIGN OR OTHERWISE.

Vishay Intertechnology, Inc., its affiliates, agents, and employees, and all persons acting on its or their behalf (collectively, "Vishay"), disclaim any and all liability for any errors, inaccuracies or incompleteness contained in any datasheet or in any other disclosure relating to any product.

Vishay makes no warranty, representation or guarantee regarding the suitability of the products for any particular purpose or the continuing production of any product. To the maximum extent permitted by applicable law, Vishay disclaims (i) any and all liability arising out of the application or use of any product, (ii) any and all liability, including without limitation special, consequential or incidental damages, and (iii) any and all implied warranties, including warranties of fitness for particular purpose, non-infringement and merchantability.

Statements regarding the suitability of products for certain types of applications are based on Vishay's knowledge of typical requirements that are often placed on Vishay products in generic applications. Such statements are not binding statements about the suitability of products for a particular application. It is the customer's responsibility to validate that a particular product with the properties described in the product specification is suitable for use in a particular application. Parameters provided in datasheets and / or specifications may vary in different applications and performance may vary over time. All operating parameters, including typical parameters, must be validated for each customer application by the customer's technical experts. Product specifications do not expand or otherwise modify Vishay's terms and conditions of purchase, including but not limited to the warranty expressed therein.

Except as expressly indicated in writing, Vishay products are not designed for use in medical, life-saving, or life-sustaining applications or for any other application in which the failure of the Vishay product could result in personal injury or death. Customers using or selling Vishay products not expressly indicated for use in such applications do so at their own risk. Please contact authorized Vishay personnel to obtain written terms and conditions regarding products designed for such applications.

No license, express or implied, by estoppel or otherwise, to any intellectual property rights is granted by this document or by any conduct of Vishay. Product names and markings noted herein may be trademarks of their respective owners.