



Comair Rotron Specification Sheet

Specification Date: Oct 13, 2016

COMAIR ROTRON PART NUMBER: 17000541A
COMAIR ROTRON MODEL NUMBER: CR9225EC-4000

A.) MOTOR:

RATED VOLTAGE:	100~240VAC \pm 10%
OPERATING VOLTAGE RANGE:	90~264VAC
LOW-START VOLTAGE:	80VAC
MAX. RUNNING CURRENT:	0.53 Amps
OPERATING FREQUENCY:	50~60Hz
INPUT POWER:	5.5 Watts
NOMINAL SPEED:	4,000 RPM \pm 5% (At Free Delivery)
MOTOR TYPE:	Brushless EC
MOTOR PROTECTION:	By Integrated Circuit
LOCKED ROTORT PROTECTION:	IC protected
POLARITY PROTECTION:	Yes
AUTOMATIC RESTART CAPABILITY:	By Integrated Circuit
ROTATION:	Counter Clockwise when viewed from the impeller

B.) MECHANICAL

DIMENSIONS:	92mm x92mm x 25mm (3.62" x 3.62" x 0.984") <i>Figure 1</i>
WEIGHT:	181g (0.399 Lbs.)
BEARING TYPE:	Permanently Lubricated Ball Bearings
VENTURI:	Die Cast magnesium alloy, ED coating and powder coating
PROPELLER:	P.B.T+30% GF(Glass fiber) UL 94V-0



Comair Rotron Specification Sheet

Specification Date: Oct 13, 2016

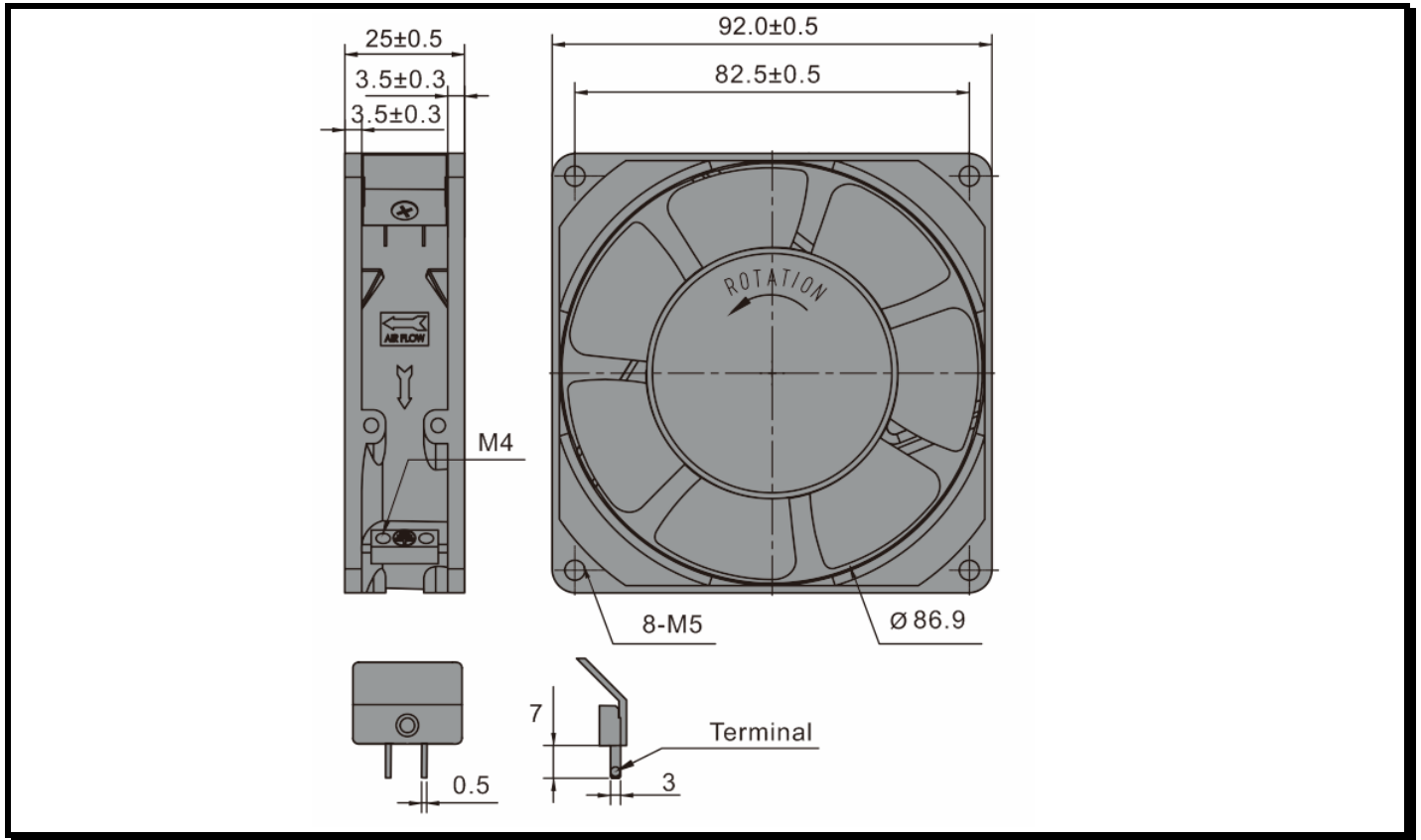

Figure 1

C.) ENVIRONMENTAL

OPERATING TEMPERATURE:	-20°C to +70°C
STORAGE TEMPERATURE:	The storage temperature will be suggested at -20°C ~ 50°C to ensure a better performance.
HUMIDITY:	20 to 85% RH, non-condensing
ENVIROMENTAL SHIELD:	IP44

D.) PERFORMANCE CHARACTERISTICS

AIR FLOW:	58 CFM ± 5% (At Free Delivery and MAX. speed)
STATIC PRESSURE:	0.26" Inches of H2O (At Shut-Off and MAX. speed)



Comair Rotron Specification Sheet

Specification Date: Oct 13, 2016

ACOUSTIC LEVEL:

43 dBA Max. at MAX. speed
(Measured via Freely Suspended at 1 meter)

E.) TERMINATION

Joint terminal:

suit with 22AWG 1007# Wire
PV1.25-3A-0.5 terminal

F.) RELIABILITY

Bearing type	Temperature	Hours
Ball bearing	20°C	60,000
	40°C	50,000
	60°C	40,000
	90°C	20,000

G.) SAFETY



K.) FLAMMABILITY

The fan including all components meets a UL94V-0 rating or better.