

LOC		DIST		P		F		ZONE		LTR		REVISIONS			
GP	00											DESCRIPTION	DATE	APPD	
												K	REVISED PER EC 0513-0291-02	10FEB03	JG

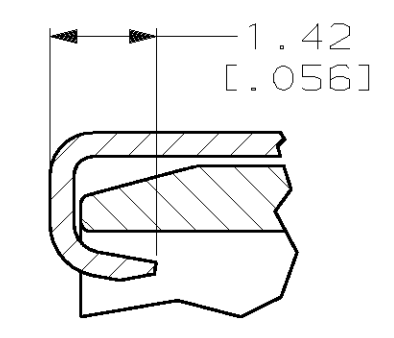

SECTION Z-Z
SCALE 10:1

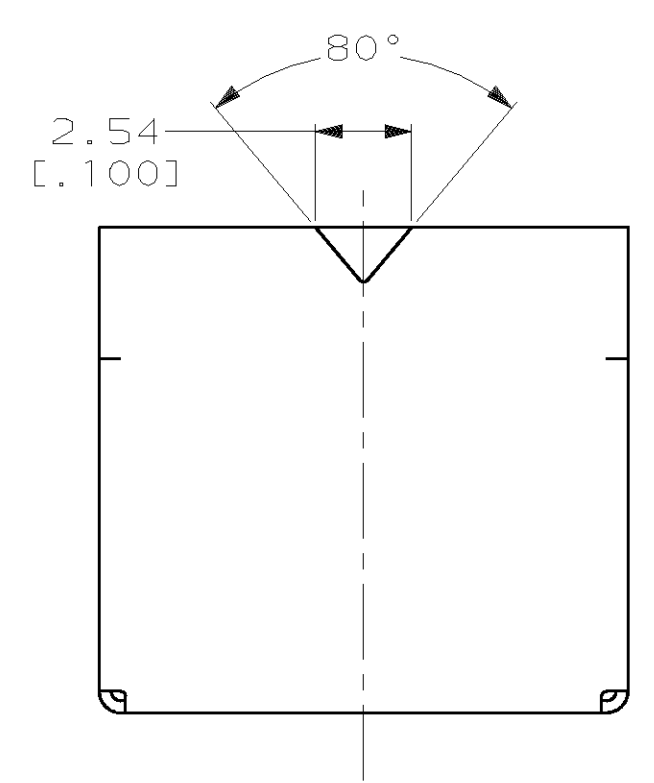
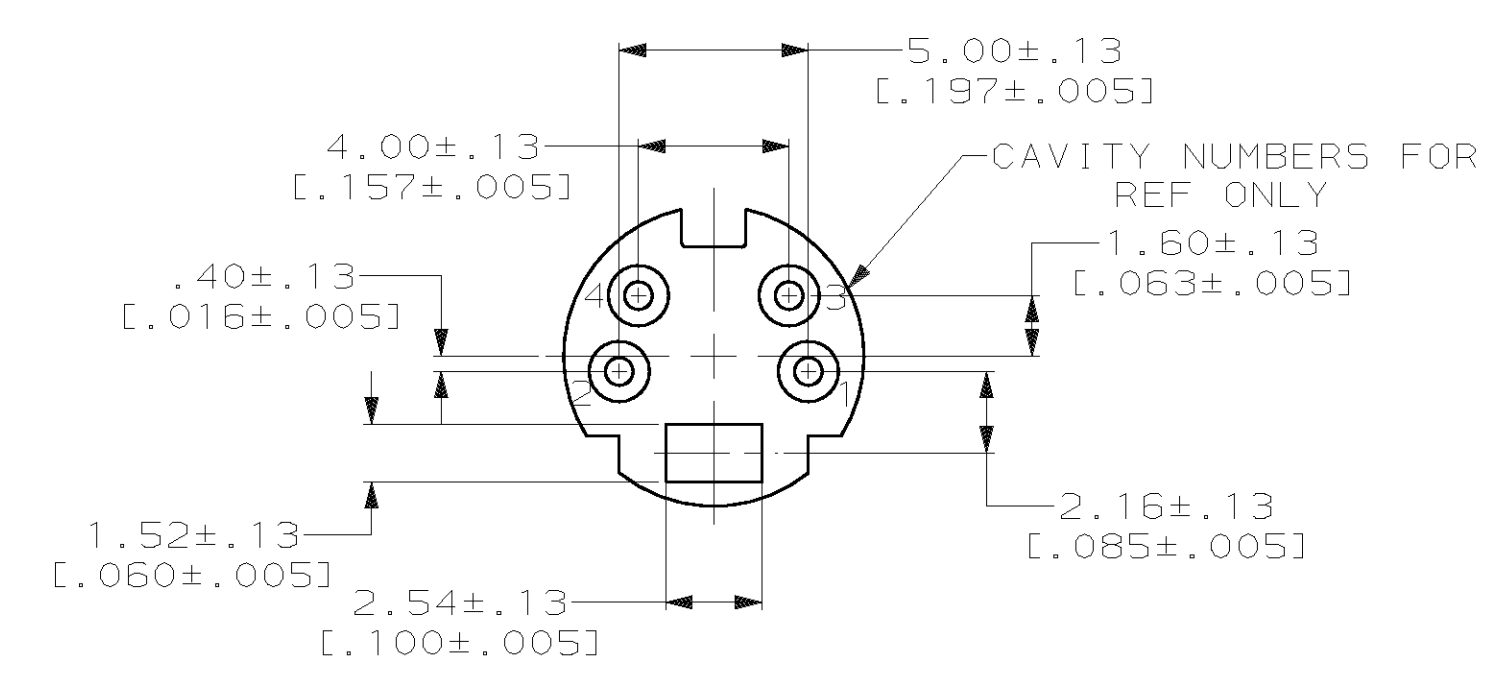

DETAIL D
4 PIN FACE

- ① RECEPTACLE CONTACTS: COPPER ALLOY.
RECEPTACLE SHIELD: COPPER ALLOY.
HOUSING: THERMOPLASTIC, COLOR; SEE TABLE, UL 94V-0 RATED.
- ② PLATING:
RECEPTACLE CONTACTS - GOLD PLATED .00076 MIN [0.00030 MIN] THICK ON MATING END, TIN-LEAD PLATED .0030 MIN [0.00120 MIN] THICK ON SOLDER TAIL ALL OVER .0013 MIN [0.00050 MIN] THICK NICKEL.
- ③ PLATING:
SHIELD: 1.50-4.00µm[0.00059-.000158] THICK BRIGHT TIN.
- 4. RECEPTACLE ASSEMBLY MATES WITH 4 PIN 9.00±.10 [0.354±.004] DIAMETER PLUG.
- ⑤ DATUMS AND BASIC DIMENSION SUPPLIED BY CUSTOMER.

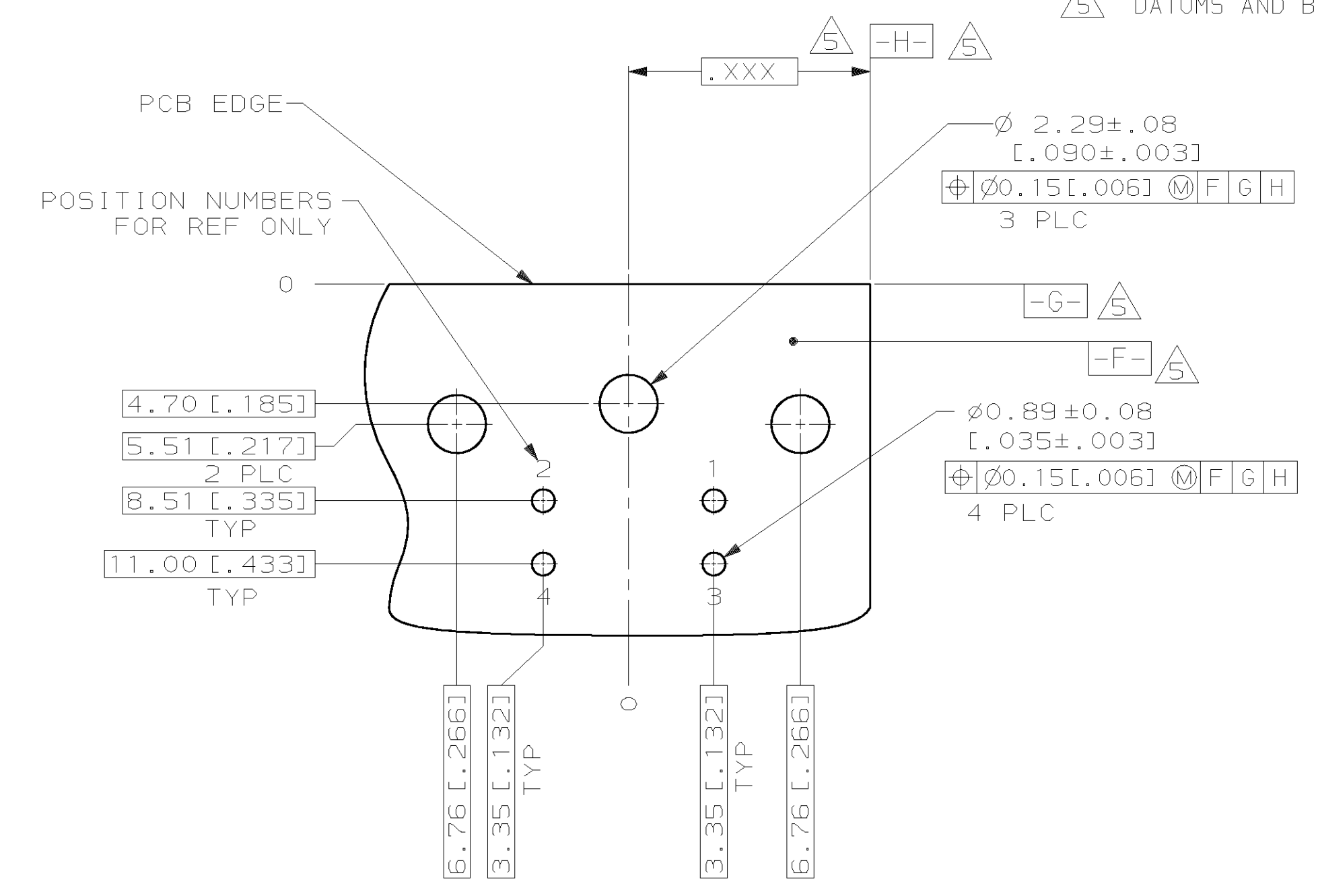
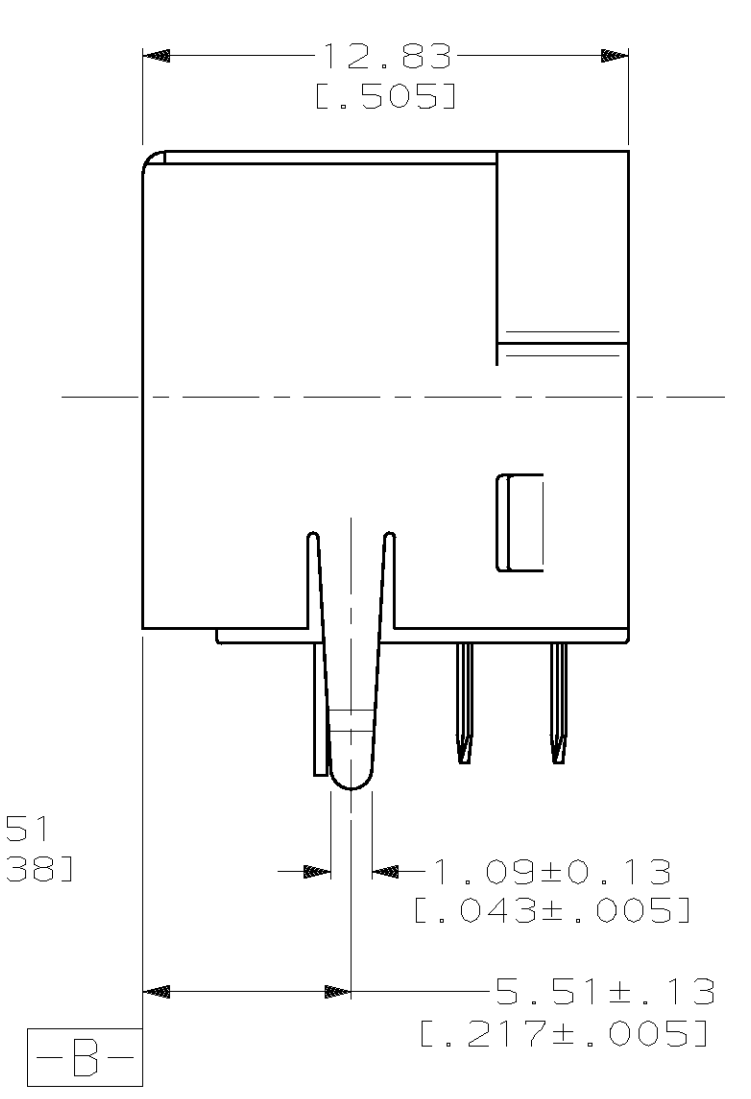
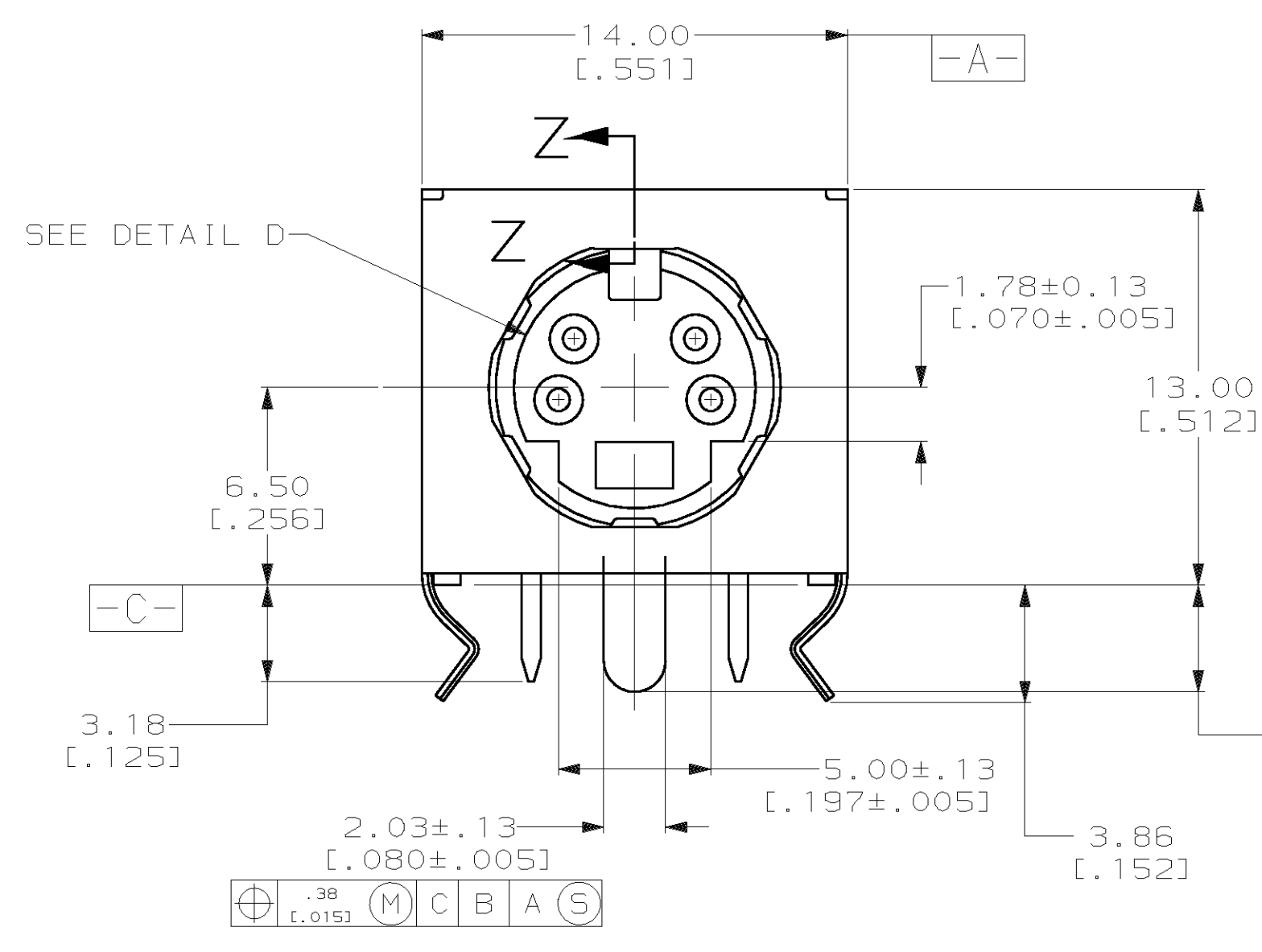

4 PIN PCB LAYOUT
BOTTOM VIEW

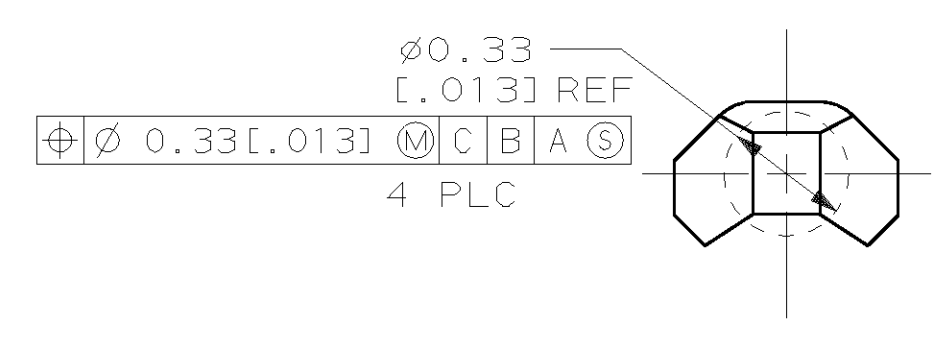
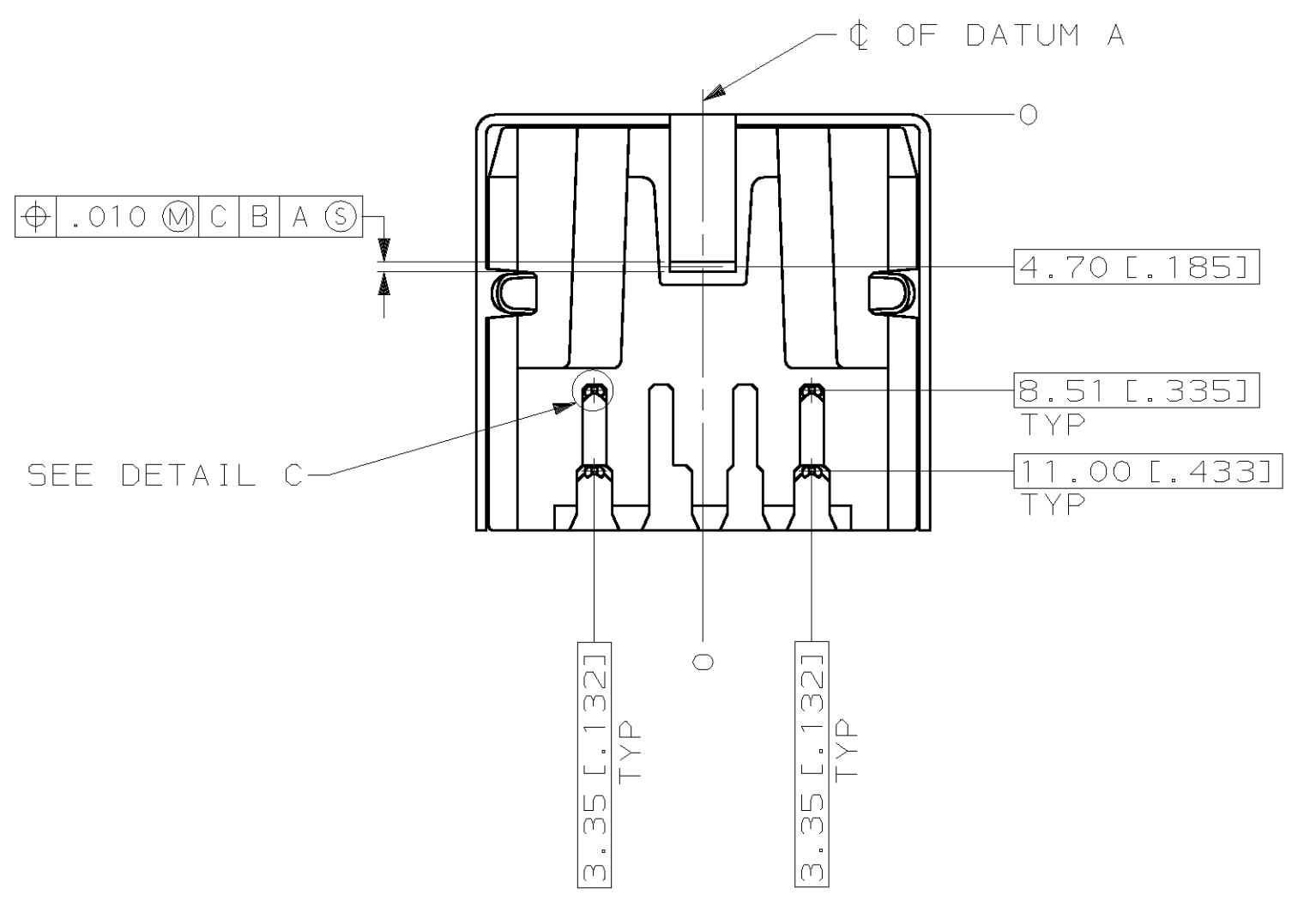

DETAIL C
SCALE 50:1

OBSOLETE	GRAY	749181-2
	BLACK	749181-1
	HOUSING COLOR	PART NO

DO NOT SCALE PRINT. UNLESS SPECIFIED DIMENSIONS IN mm [INCHES] TOLERANCES ON:		DR 1-24-89 P.005M05		AMP INCORPORATED Harrisburg, Pa. 17105	
2 PLC DEC ±		CHK 1-24-89 C.0HL			
3 PLC DEC ± 0.381 [0.015]		APPD 1-24-89 B.H.MOSSER		NAME	
ANGLES ± 0°30'		APPD 1-24-89 E.C.MYERS		RECEPTACLE ASSY W/HOLD DOWN, 4 POS RIGHT ANGLE, MINIATURE CIRCULAR DIN	
MATERIAL		PRODUCT SPEC 108-1225		SIZE	
FINISH		APPLICATION SPEC 114-40031		FSCM NO 00779	
WEIGHT		DRAWING NO 749181		SCALE 5:1	
		SHEET 1 OF 1			