

1500V MOS Gated Thyristor

IXHH40N150HV

$V_{DM} = 1500V$

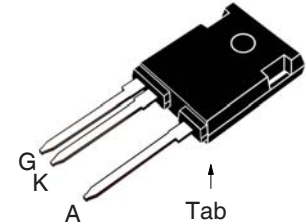

TO-247HV

 G = Gate
A = Anode

 K = Cathode
Tab = Anode

Symbol	Test Conditions	Maximum Ratings	
V_{DM}	$T_J = 25^\circ\text{C to } 150^\circ\text{C}$	1500	V
V_{GK}	Continuous	± 30	V
V_{GK}	Transient	± 40	V
I_{TSM}	$T_C = 25^\circ\text{C}, 1\mu\text{s}$	7.6	kA
	$T_C = 25^\circ\text{C}, 10\mu\text{s}$	3.5	kA
P_D	$T_C = 25^\circ\text{C}$	695	W
T_J		-55 ... +150	$^\circ\text{C}$
T_{JM}		150	$^\circ\text{C}$
T_{stg}		-55 ... +150	$^\circ\text{C}$
T_L	Maximum Lead Temperature for Soldering	300	$^\circ\text{C}$
T_{SOLD}	1.6 mm (0.062 in.) from Case for 10s	260	$^\circ\text{C}$
M_d	Mounting Torque	1.13/10	Nm/lb.in
Weight		6	g

Features

- Very High Voltage Package
- Very High Current Capability

Advantages

- High Power Density
- Low Gate Drive Requirement

Applications

- Capacitive Discharge Circuits
- Ignition Circuits
- Solid State Surge Protection

Symbol	Test Conditions ($T_J = 25^\circ\text{C}$, Unless Otherwise Specified)	Characteristic Values		
		Min.	Typ.	Max.
V_{BR}	$I_A = 250\mu\text{A}, V_{GK} = 0V$	1500		V
$V_{GK(th)}$	$I_A = 250\mu\text{A}, V_{AK} = V_{GK}$	2.5		5.0 V
V_T	$I_T = 1000A, V_{GK} = 15V$		5.95	7.5 V
r_T	$I_T > I_L, V_{GK} = 15V$		1.20	m Ω
V_{BO}	$V_{GK} = 15V$		6.45	V
I_D	$V_{AK} = 1500V, V_{GK} = 0V$ $T_J = 125^\circ\text{C}$			15 μA
				1 mA
I_L I_H			250	A
			200	A
I_{GKS}	$V_{AK} = 0V, V_{GK} = \pm 30V$			± 200 nA

Symbol Test Conditions ($T_J = 25^\circ\text{C}$ Unless Otherwise Specified)		Characteristic Values		
		Min.	Typ.	Max.
C_{iks}	} $V_{AK} = 25\text{V}, V_{GK} = 0\text{V}, f = 1\text{MHz}$		2825	pF
C_{oks}			164	pF
C_{rks}			50	pF
$Q_{g(on)}$	} $I_C = 40\text{A}, V_{GK} = 15\text{V}, V_{AK} = 600\text{V}$		99	nC
Q_{gk}			22	nC
Q_{ga}			36	nC
t_{ri}	} Capacitive Discharge, $T_J = 25^\circ\text{C}$ $I_A = 2000\text{A}, V_{GK} = 15\text{V}, R_G = 1\Omega$		100	ns
t_d		$V_{AK} = 1000\text{V}, L < 20\text{nH}$, Notes 2 & 3		50
t_{ri}	} Capacitive Discharge, $T_J = 125^\circ\text{C}$ $I_A = 2000\text{A}, V_{GK} = 15\text{V}, R_G = 1\Omega$		100	ns
t_d		$V_{AK} = 1000\text{V}, L < 20\text{nH}$, Notes 2 & 3		50
R_{thJC}				0.18 $^\circ\text{C/W}$
R_{thCS}		0.21		$^\circ\text{C/W}$

TO-247HV Outline

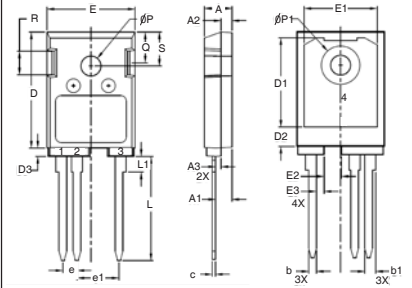

PINS:
1 - Gate 2 - Cathode
3, 4 - Anode

SYM	INCHES		MILLIMETERS	
	MIN	MAX	MIN	MAX
A	.193	.201	4.90	5.10
A1	.114	.122	2.90	3.10
A2	.075	.083	1.90	2.10
A3	.035	.043	0.90	1.10
b	.053	.059	1.35	1.50
b1	.075	.083	1.90	2.10
c	.022	.030	0.55	0.75
D	.819	.843	20.80	21.40
D1	.638	.646	16.20	16.40
D2	.134	.146	3.40	3.70
D3	.055	.063	1.40	1.60
E	.622	.638	15.80	16.20
E1	.520	.528	13.20	13.40
E2	.118	.126	3.00	3.20
E3	.051	.059	1.30	1.50
e	.100	BSC	2.54	BSC
e1	.300	BSC	7.62	BSC
L	.732	.748	18.60	19.00
L1	.106	.118	2.70	3.00
phi P	.138	.142	3.50	3.60
phi P1	.272	.280	6.90	7.10
Q	.216	.224	5.50	5.70
R	.165	.169	4.20	4.30
S	.240	.248	6.10	6.30

Notes:

1. Pulse test, $t \leq 300\mu\text{s}$, duty cycle, $d \leq 2\%$.
2. It is recommended to use a gate driver capable of supplying more than 4Amps and $\geq 15\text{V}$ gate voltage.
3. Refer to fig. 8 & 9.

PRELIMINARY TECHNICAL INFORMATION

The product presented herein is under development. The Technical Specifications offered are derived from a subjective evaluation of the design, based upon prior knowledge and experience, and constitute a "considered reflection" of the anticipated result. IXYS reserves the right to change limits, test conditions, and dimensions without notice.

IXYS Reserves the Right to Change Limits, Test Conditions, and Dimensions.

IXYS MOSFETs and IGBTs are covered by one or more of the following U.S. patents:	4,835,592	4,931,844	5,049,961	5,237,481	6,162,665	6,404,065 B1	6,683,344	6,727,585	7,005,734 B2	7,157,338B2
	4,860,072	5,017,508	5,063,307	5,381,025	6,259,123 B1	6,534,343	6,710,405 B2	6,759,692	7,063,975 B2	
	4,881,106	5,034,796	5,187,117	5,486,715	6,306,728 B1	6,583,505	6,710,463	6,771,478 B2	7,071,537	

Fig. 1. Extended Output Characteristics @ $T_J = 25^\circ\text{C}$

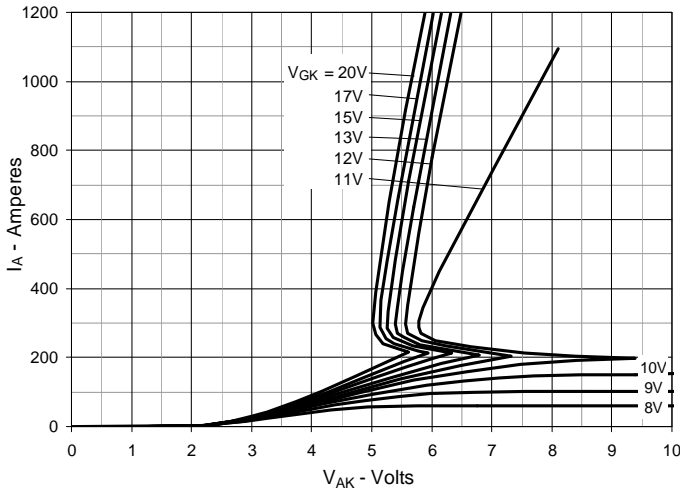

Fig. 2. Extended Output Characteristics @ $T_J = 125^\circ\text{C}$

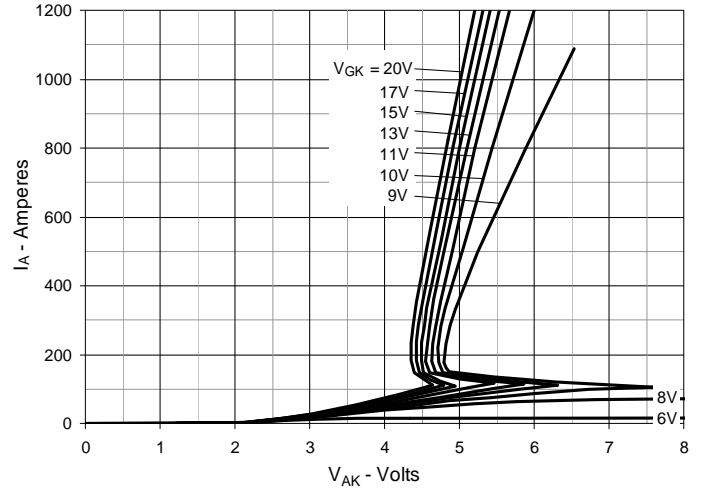

Fig. 3. Extended Output Characteristics @ $T_J = -40^\circ\text{C}$

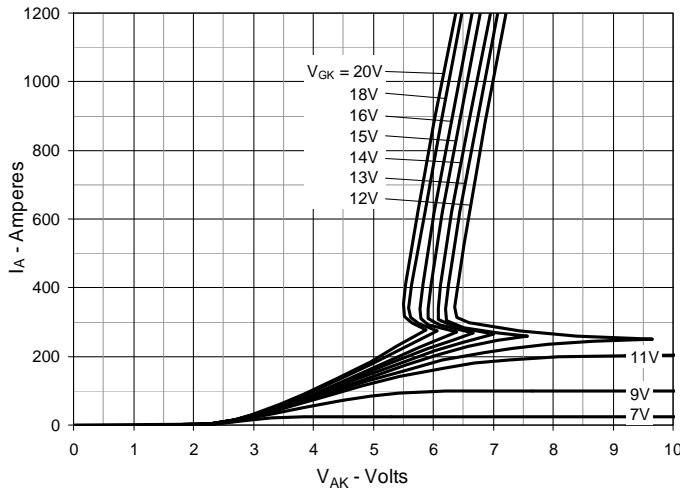

Fig. 4. Gate Charge

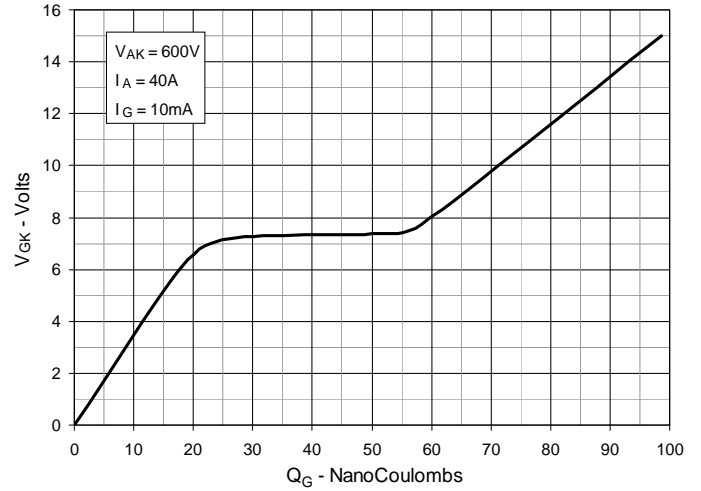

Fig. 5. Capacitance

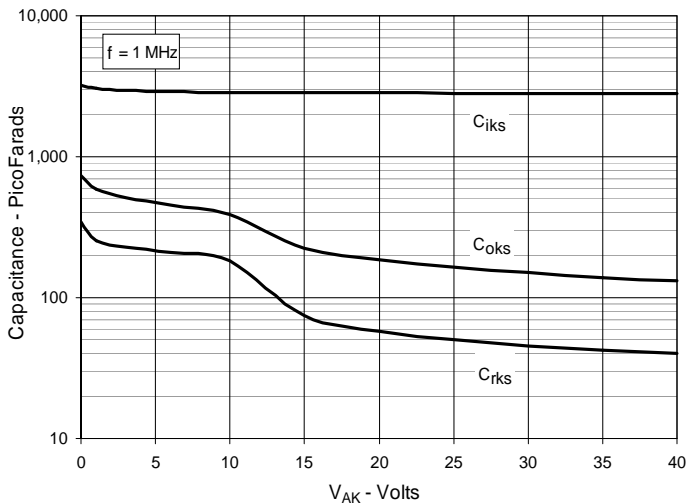

Fig. 6. Maximum Transient Thermal Impedance

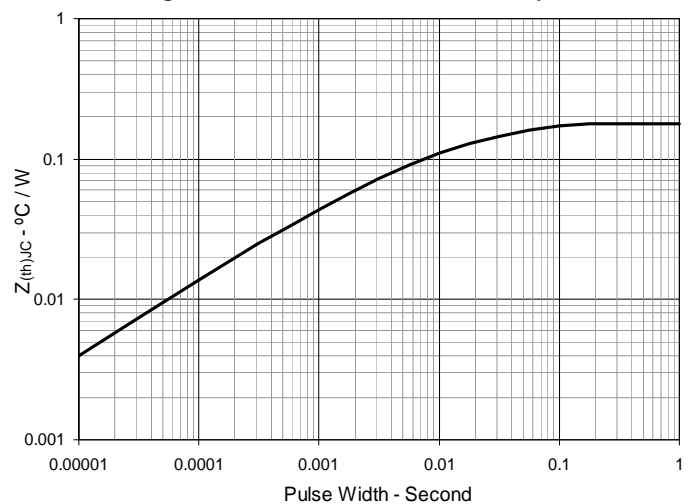
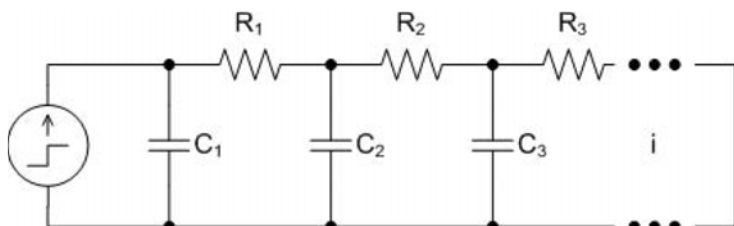

Fig. 7. Cauer Thermal Network



i	Ri (Ω)	Ci (F)
1	0.015004	0.005397
2	0.071079	0.028026
3	0.051007	0.121930
4	0.002310	2.500000

Fig. 8. Capacitive Discharge

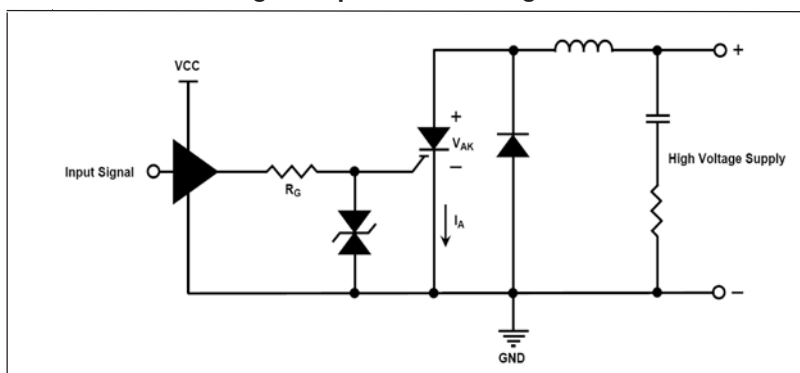

Fig. 9. Capacitive Discharge Waveform

