

User Manual

ULINX USR602 & USR604

2 & 4 Port USB Isolated Serial Converters



USR60x Series

Documentation Number:USR60x-2112m

This product was designed and manufactured in Ottawa, Illinois USA
using domestic and imported parts by:



International Headquarters:

707 Dayton Road
Ottawa, IL 61350 USA
Phone: (815) 433-5100
Website: www.bb-elec.com

European Headquarters:

Westlink Commercial Park
Oranmore, Co. Galway, Ireland
Phone: (+353) 91-792444
Website: www.bb-europe.com

Original – April 2011

©2011 No part of this publication may be reproduced or transmitted in any form or by any means, electronic or mechanical, including photography, recording, or any information storage and retrieval system without written consent. Information in this manual is subject to change without notice, and does not represent a commitment on the part .

B&B Electronics Manufacturing shall not be liable for incidental or consequential damages resulting from the furnishing, performance, or use of this manual.

All brand names used in this manual are the registered trademarks of their respective owners. The use of trademarks or other designations in this publication is for reference purposes only and does not constitute an endorsement by the trademark holder.

This document was created using Author-it, Microsoft Word, Adobe Acrobat, Snag It and other software.

Table of Contents

| | |
|---|-----------|
| User Manual | 1 |
| Ulinx USR602 & USR604 | 1 |
| Overview | 5 |
| Safety | 6 |
| Product Feature Summary | 6 |
| About this Manual | 6 |
| Product Information..... | 7 |
| USR60x Models | 7 |
| Package Contents | 7 |
| Typical Applications / Modes of Operation | 8 |
| Quick Start Guide | 9 |
| Software Installation | 13 |
| Installing the Driver | 13 |
| Un-Installing the Driver | 16 |
| Hardware Installation | 17 |
| Installing and Mounting the USR60x..... | 18 |
| Connecting Power | 18 |
| Connecting to a PC | 19 |
| Connecting to the Serial Ports | 20 |
| Termination and Biasing | 21 |
| Setting COM Port Operating Modes | 21 |
| LED Indicators..... | 23 |
| Advanced User Settings..... | 25 |
| Setting Serial Port Properties | 26 |
| Advanced Settings in Device Manager | 27 |
| Modbus Basics..... | 30 |
| Specifications | 31 |
| Product Specifications | 32 |
| Certifications..... | 33 |
| Default Settings | 34 |

| | |
|-----------------------------|-----------|
| USR602 Dimensions..... | 35 |
| USR604 Dimensions..... | 36 |
| Panel Mount Dimensions..... | 37 |
| Appendix | 39 |
| Loopback Test | 39 |
| Serial Port Wiring | 42 |
| Index | 45 |

SECTION 1

Overview

In This Section

Safety
Product Feature Summary.....
About this Manual

The USR60x family of products are industrial grade isolated USB to serial converters. They enable any host USB port to provide multiple RS-232, RS-422 or RS-485 two or four-wire serial interfaces. The USR602 provides two ports; the USR604 provides four ports.

USR60x converters support USB 2.0 high speed data rates of 480 Mbps. The upstream and downstream sections are isolated to 2000 volts. Industrial features such as a rugged metal case, versatile mounting options, high ESD protection, wide temperature ranges, and high retention USB connectors set these devices apart from other USB to serial converters.



Figure 1: USR602 USB to Serial Converter

Safety

All safety related regulations, local codes and instructions that appear in the literature or on equipment must be observed to ensure personal safety and to prevent damage to either the instrument or equipment connected to it. If equipment is used in a manner not specified by the manufacturer, the protection provided by the equipment may be impaired.

Product Feature Summary

- Easy to install
- 2 kV port to port isolation
- High retention USB connector
- Rugged metal case
- DIN rail or panel mount options included
- 8 kV contact, 15 kV air ESD surge protection
- Wide temperature range (-40 to 80° C)
- USB 2.0 and 1.1 compatible
- LEDs indicate power and port status
- Includes 2 meter USB cable
- USB powered (USR602 only) or externally powered
- Redundant power inputs (10 to 48 VDC) via terminal block or locking barrel jack
- Drivers for Windows 2000 and up (including 64 bit variants)
- RS-232, RS-422, RS-485 two-wire and RS-485 four-wire interfaces
- Modbus support
- 2 or 4 port models

About this Manual

The content of this manual has been designed to be used by personnel who have a basic understanding of computer systems and peripherals, data communications, serial communications protocols (RS-232/422/485), and basic electronics.

SECTION 2

Product Information

In This Section

| |
|---|
| USR60x Models |
| Package Contents..... |
| Typical Applications / Modes of Operation |

USR60x Models

The USR60x is a family of USB to serial converters. Models currently available include:

- USR602 - Two Port Isolated USB to Serial Converter
- USR604 - Four Port Isolated USB to Serial Converter

Package Contents

- USR602 or USR604 Isolated USB to Serial Converter
- Driver CD
- 2 meter USB cable
- Panel mount adapters
- DIN rail mount adapter
- Quick start guide

Typical Applications / Modes of Operation

- Addition of serial ports to PCs
- Conversion of USB serial connection to:
 - RS-232
 - RS-422
 - RS-485 two-wire
 - RS-485 four-wire

SECTION 3

Quick Start Guide

The following Quick Start Guide outlines the basic steps to get your USR60x Converter up and running:

1. Check for included items
 - 2 or 4 port industrial USB to serial converter
 - Two meter USB cable
 - Panel mount adapters
 - DIN rail mount adapter
 - Driver CD
 - This quick start guide
2. Install the driver software (see "Installing the Driver" on page 13)
 - The CD contains a driver installation program. Install the drivers before connecting the converter to your PC.
 - Put CD into drive. The installation program should launch automatically.
 - Follow the prompts
3. Mount the converter (DIN rail or panel mount)
 - DIN Rail
 - Locate DIN rail kit
 - Mount on back of converter using screws
 - Clip to a DIN rail
 - Panel mount:
 - Locate the panel mount kit
 - Mount brackets to converter using screws
 - Mount in panel
4. Connect power (see "Connecting Power" on page 18):
 - USR602: Plug USB cable from PC into converter

- USR604: Connect 10 to 48VDC to terminal block and/or barrel jack
5. Check LED Indicators (on page 23)
 - Power indicated by green Pwr LED
 - Tx and Rx LEDs will indicate when data present
 6. Set up the COM Port operating modes (see "Setting COM Port Operating Modes" on page 21)
 - Configure the DIP switches for each port to select one of the following:
 - RS-232 (Both DIP switches Off)
 - RS-422 (Both DIP switches On)
 - RS-485 4-wire (SW1 Off, SW2 On)
 - RS-485 2-wire (SW1 On, SW2 Off)
 7. Connect the serial ports (see "Connecting to the Serial Ports" on page 20):
 - Connect from the DB-9M connectors on the converter to your devices or network:
 - To connect to an RS-232 DTE device, use a null modem (crossover) cable
 - To connect to an RS-485 two-wire network, refer to RS-485 Two-Wire Connections (on page 43)
 - To connector an RS-422 device, or an RS-485 four-wire network, refer to RS-422 and RS-485 Four-Wire Connections (on page 44)
 8. Configure the serial ports (see "Advanced Settings in Device Manager" on page 27)
 - On the PC screen, open the Control Panel.
 - Click System to open the Device Manager
 - Under Ports, double-click the port to be configured.
 - On the Serial Port Properties window, set the required communications parameters of system with which you are communicating.
 - If necessary, click Advanced and set up the Advanced Properties (refer to manual for information)

9. Perform a loopback test to verify that the converter is working.
 - Refer to the [Loopback Test](#) (on page 39) section

SECTION 4

Software Installation

In This Section

Installing the Driver.....
Un-Installing the Driver.....

Do not connect the converter to your PC until the Driver is installed. The driver is contained on the CD included with the converter. It is installed using an executable program. This program must be run on your PC before connecting the converter to your USB port.

Installing the Driver

Insert the CD into your CD ROM Drive. The driver installation software should automatically start. If not, browse the CD and double click on the "setup.exe" file. The following dialog box will appear.

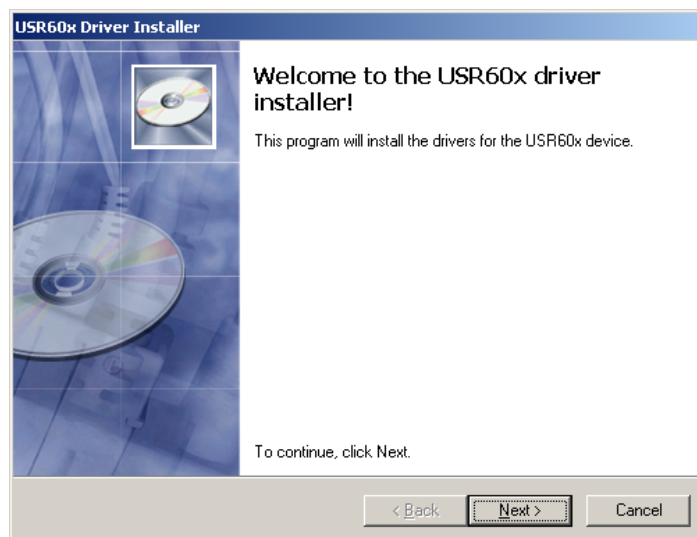

Figure 2: Run setup.exe dialog

1. Click Next. The license agreement dialog box will appear.

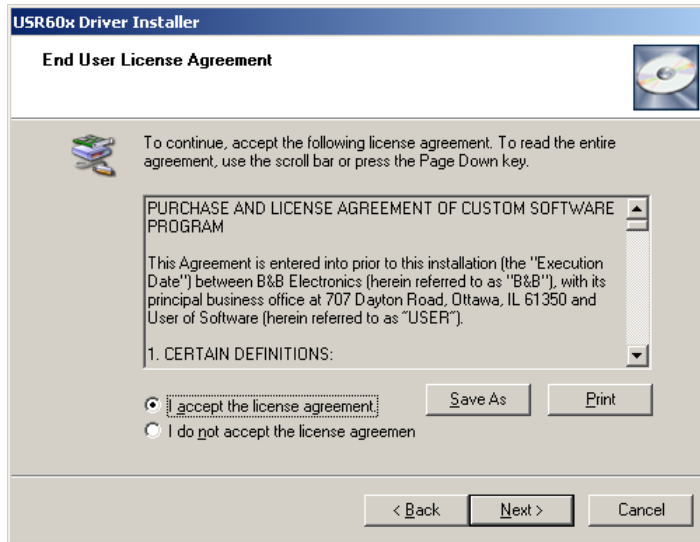

Figure 3: End User License Agreement

2. Click Next. The program will install the drivers on your computer and the installation complete screen will appear.



Figure 4: Installation Complete Screen

3. When the installation is complete you can plug in the USB to Serial Converter. When you do this, the COM ports will be assigned. It may take up to 30 seconds to make the COM port assignments the first time you plug in the converter.
4. The driver software is now installed.
5. To verify that the communication port has been configured:
 - a. Open the **Control Panel**
 - b. Click **System** to open the System Properties dialog box.
 - c. Select the **Hardware** tab.
 - d. Click **Device Manager** to open the Device Manager dialog box.
 - e. Expand **Ports (COM & LPT)**
USB Isolated Serial Port should be listed as one of the COM ports.

Un-Installing the Driver

To un-install the driver for the USR60x converter:

1. Open the **Control Panel**
2. Click **System** to open the System Properties dialog box.
3. Select the **Hardware** tab.
4. Click **Device Manager** to open the Device Manager dialog box.
5. Expand **Ports (COM & LPT)**
USB Isolated Serial Port should be listed as one of the COM ports.
6. Right-click the COM port listing for the converter (**USB Isolated Serial Port**)

The following dialog box appears.



7. Click OK.

The Com port listing for the converter disappears.

SECTION 5

Hardware Installation

In This Section

- Installing and Mounting the USR60x
- Connecting Power
- Connecting to a PC.....
- Connecting to the Serial Ports
- Termination and Biasing
- Setting COM Port Operating Modes.....
- LED Indicators

Hardware installation includes mounting the device, connecting power, connecting to a PC, connecting to serial devices and configuring the serial ports. LEDs indicate the presence of power and communications signals on the ports.



Figure 5: USR602

Installing and Mounting the USR60x

USR60x converters come supplied with DIN rail mounting clips and panel mount adapters.



Figure 6: DIN Rail Mounting Clip

The DIN rail mounting clip is attached to the back of the unit using three machine screws (included). This mount enables the unit to be clipped directly to a standard DIN rail.

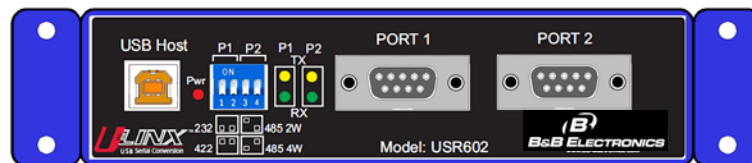

Figure 7: USR602 with Panel Mount Adapters

Panel mount adapters are attached to the unit with three machine screws on each side. With this mount the unit can be installed in a panel. (Refer to dimensional diagrams for the dimensions required for predrilling the panel.)

Connecting Power

USR60x converters offer three options for connection of power:

- USB bus powered

Section 5 - Hardware Installation

- External power via pluggable terminal strip - 10 to 48 VDC, 16 watts max
- External power via locking power jack - 10 to 48 VDC, 16 watts max

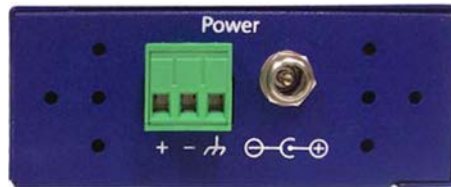

Figure 8: Power Supply Connections

When the unit is USB powered the current available to the converter may be limited by the USB host. If the converter is connected to an external USB hub the maximum available current may be insufficient to operate the converter. In that case an external power supply should be connected.

Connecting to a PC

USR60x converters connect to a host device (PC) via a USB interface. The connector on the USR60x converter is a high retention force Type B female connector.



Figure 9: USB Connector

Connecting to the Serial Ports

The USR602 provides two serial ports; the USR604 has four. DB-9M connectors are used for RS-232, RS-422 and RS-485 two-wire and four-wire connections.



Figure 10: DB-9M Serial Port Connectors

The following illustration shows the pin numbering of the DB-9M connector.



Figure 11: DB-9F Pin Numbering

The following table shows the wiring pin-outs for RS-232, RS-422 and RS-485 two-wire and four-wire connections.

| Pins | RS-232 (DTE) | RS-422/RS-485 (4-wire) | RS-485 (2-wire) |
|------|---------------------------|------------------------|-----------------|
| 1 | Data Carrier Detect (DCD) | RDA(-) | --- |
| 2 | Receive Data (RD) | RDB(+) | --- |
| 3 | Transmit Data (TD) | TDB(+) | DATA B(+) |
| 4 | Data Terminal Ready (DTR) | TDA(-) | DATA A(-) |
| 5 | Signal Ground (GND) | GND | GND |
| 6 | Data Set Ready (DSR) | --- | --- |
| 7 | Request To Send (RTS) | --- | --- |
| 8 | Clear To Send (CTS) | --- | --- |
| 9 | Not Used | --- | --- |

Termination and Biasing

USR60x converters include internal biasing resistors on the RS-422/RS-485 interfaces.

The values for internal biasing resistors are:

Biasing: 1k ohms (default IN PLACE when in RS-422/485 modes)

The biasing resistors are connected to the receive lines, pulling the RDA(-) line to ground and the RDB(+) line to a positive voltage. The bias resistor is automatically IN when you select RS-422/485 mode.

For additional information on termination and biasing download the RS-442 and RS-485 Applications eBook from www.bb-elec.com or contact Technical Support at B&B Electronics: 815-433-5100

Setting COM Port Operating Modes

The operating modes of the converter are configured by the positions of DIP switches accessible on the USR60x enclosure. The DIP switches on the USR602 are located on the front panel of the converter.

- Switches 1 and 2 configure Port 1
- Switches 3 and 4 configure Port 2



Figure 122: DIP Switches

The DIP switches on the USR604 are located on the top of the enclosure near the power connectors (when the unit is positioned vertically).

- Switches 1 and 2 configure Port 1
- Switches 3 and 4 configure Port 2

Section 5 - Hardware Installation

- Switches 5 and 6 configure Port 3
- Switches 7 and 8 configure Port 4.

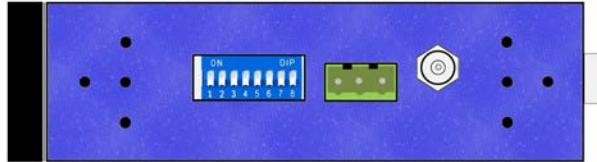

Figure 133: USR604 DIP Switch and Power Connectors

Operating modes are RS-232, RS-485 two-wire half-duplex, RS-485 four-wire full-duplex, and RS-422.

| Port | Switch | RS-232 | RS-422 | RS-485 4-wire | RS-485 2-wire |
|--------|--------|------------|---------|------------------|------------------|
| Port 1 | 1 | Off (down) | On (up) | Off (down) | On (up) |
| | 2 | Off (down) | On (up) | On (up) | Off (down) |
| Port 2 | 3 | Off (down) | On (up) | Off (down) | On (up) |
| | 4 | Off (down) | On (up) | On (up) | Off (down) |
| Port 3 | 5 | Off (down) | On (up) | Off (down) | On (up) |
| | 6 | Off (down) | On (up) | On (up) | Off (down) |
| Port 4 | 7 | Off (down) | On (up) | Off (down) | On (up) |
| | 8 | Off (down) | On (up) | On (up) | Off (down) |

LED Indicators

USR602 converters include five LED indicators; USR604 converters include nine LED indicators. In both models one indicates the presence of power; the others indicate transmit and receive data present on each port.



Figure 144: USR602 LED Indicators

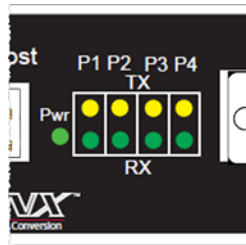

Figure 155: USR604 LED Indicators

| LED Function | Color | Indicates |
|--------------|-----------------|----------------------------------|
| Power | Green | Presence of power |
| Port 1 Rx | Blinking Green | Data being received on Port 1 |
| Port 1 Tx | Blinking Yellow | Data being transmitted on Port 1 |
| Port 2 Rx | Blinking Green | Data being received on Port 2 |
| Port 2 Tx | Blinking Yellow | Data being transmitted on Port 2 |
| Port 3 Rx | Blinking Green | Data being received on Port 3 |
| Port 3 Tx | Blinking Yellow | Data being transmitted on Port 3 |
| Port 4 Rx | Blinking Green | Data being received on Port 4 |
| Port 4 Tx | Blinking Yellow | Data being transmitted on Port 4 |

SECTION 6

Advanced User Settings

In This Section

- Setting Serial Port Properties.....
- Advanced Settings in Device Manager
- Modbus Basics

Serial port parameters and other advanced settings are configured on the USB Isolated Serial Port Properties and Advanced Settings windows, which are accessible via the Device Manager. The Device Manager can be accessed through the Windows Control Panel.

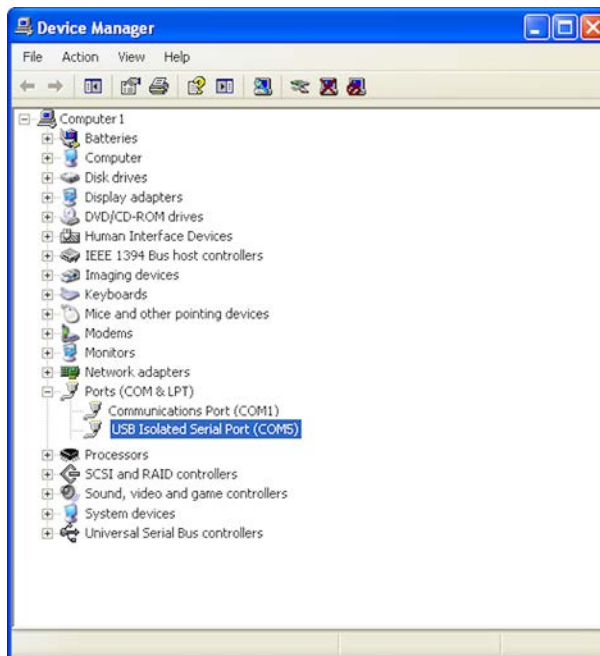

Figure 166: Device Manager

Setting Serial Port Properties

1. In Device Manager, expand Ports and double-click USB Isolated Serial Port to open the USB Isolated Serial Port Properties dialog box.

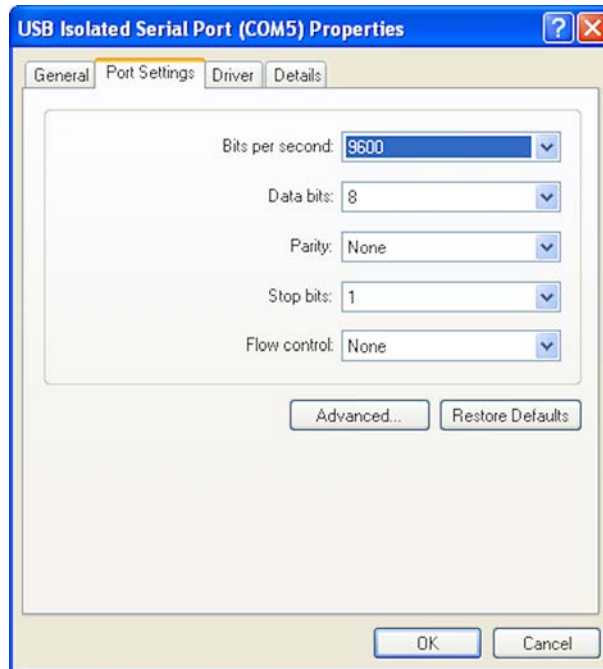

Figure 177: Port Properties

2. In the dropdown lists provided, select the following serial port properties required for your communications application:
 - Bits per second
 - Data bits
 - Parity
 - Stop bits
 - Flow control

Note: The default values for this dialog are 9600 bps, 8 data bits, No parity, 1 stop bit, No flow control

Advanced Settings in Device Manager

To configure advanced settings, on the USB Isolated Serial Port Properties dialog, click Advanced...

The Advanced Settings dialog appears.

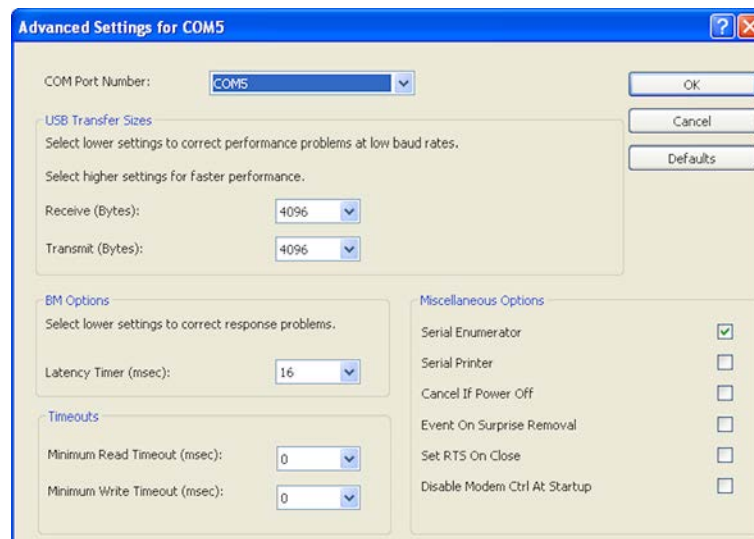

Figure 188: Advanced Settings

Configure the advanced settings as required (refer to the following sections for details) and click OK to store the settings.

COM Port Number

When installing the drivers the first available COM port number is assigned to the first COM port on the USR60x device.

If necessary the default communications port number can be changed by selecting a new number in the COM Port Number dropdown list.

USB Transfer Sizes

Receive and transmit message sizes between 64 bytes and 4096 bytes can be selected. The default value is 4096.

Select lower settings to correct performance problems at low baud rates. Select higher settings for faster performance.

BM Options

The BM Options dropdown list provides a setting for the Latency Timer. The latency timer is a form of time-out mechanism that counts from the last time data was sent from the USB60x back to the PC. If the latency timer expires, the USB60x will send any data it has available to the PC. It then resets and begins counting again.

Timer settings from 1 to 255 msec are available. The default value is 16 msec.

Select lower settings to correct response problems.

Timeouts

The USB timeout is the maximum time in milliseconds that a USB request can remain outstanding. Minimum read and write timeout values between 0 and 10000 msec can be selected.

The default values are 0 for both read and write timeouts.

Miscellaneous Options

The following settings can be selected or deselected by clicking the appropriate checkbox:

Serial Enumerator - The function of the serial enumerator is to detect a Plug-and-Play enabled device (such as a serial mouse or serial modem) that is attached to the USB serial port.

Serial Printer - If enabled, serial printer will disable timeouts to allow for long delays associated with paper loading.

Cancel If Power Off - The Cancel If Power Off option can be used to assist with problems encountered when going into a hibernate or suspend condition. This will cancel any requests received by the driver when going into hibernate or suspend.

Event On Surprise Removal - The Event On Surprise Removal option is generally left unselected.

Set RTS On Close - Selecting the Set RTS On Close option will set the RTS signal on closing the port.

Disable Modem Ctrl At Startup - This option is used to control the modem control signals DTR and RTS at startup. Devices that monitor these signals can enter the wrong state after an unplug-replug cycle on USB.

Modbus Basics

Modbus is an industrial data communications protocol that emerged in the mid-1970s and continues to be widely used in current industrial systems. Originally designed to link terminals with Modicon PLCs, it is simple, easy to learn and implement, and free to use. It quickly became a defacto standard in the industry and has been widely implemented with successful results.

Modbus is a message-based master/slave protocol (also sometimes referred to as master/client) typically implemented across serial communications links such as RS-232, RS-422 and RS-485. It supports asynchronous point-to-point and multidrop communications.

The original Modbus specification included two possible transmission modes: ASCII and RTU. Modbus RTU mode is the most common implementation, using binary coding and CRC error-checking. Modbus ASCII messages (though somewhat more readable because they use ASCII characters) is less efficient and uses less effective LRC error checking. ASCII mode uses ASCII characters to begin and end messages whereas RTU uses time gaps (3.5 character times) of silence for framing. The two modes are incompatible so a device configured for ASCII mode cannot communicate with one using RTU.

Although some newer equipment using Modbus incorporates USB interfaces, most legacy equipment implements RS-232, RS-422 and RS-485. Most new PCs have eliminated RS-232 ports as standard features and RS-422/485 was never a standard feature. As a result USB to serial converters such as the USR60x are often necessary to communicate between PCs and legacy systems that implement Modbus protocol.

SECTION 7

Specifications

In This Section

| |
|-----------------------------|
| Product Specifications..... |
| Certifications..... |
| Default Settings |
| USR602 Dimensions |
| USR604 Dimensions |
| Panel Mount Dimensions..... |

Product Specifications

| Category | Specification |
|------------------------------------|--|
| Models | USR602, USR604 |
| User documentation | User manual: on CD and B&B website Data sheet: on B&B website Quick Start Guide: Printed |
| Software | Included on CD |
| Operating Systems Supported | Server 2008 R2, Windows 7, Windows 7 x64, Windows Server 2008, Windows Server 2008 x64, Windows Vista, Windows Vista x64, Windows Server 2003, Windows Server 2003 x64, Windows XP, Windows XP x64, Windows 2000 |
| Dimensions | USR602: 5.440in x 1.4in x 3.5in (13.8cm x 3.54cm x 8.75cm) USR604: 8.00in x 1.4in x 4.70in (20.30cm x 3.54cm x 12.0cm) |
| Protocols | USB 1.1 and 2.0 |
| Speed | 1.5Mbps, 12 Mbps, 480 Mbps |
| Isolation | 2 kV port to port |
| Upstream connector | Type B high retention (15 Newton / 3.4 lbs withdrawal force) |
| Serial connector | One DB-9M connector for each serial port |
| Serial modes | R-232 (DTE), RS-485 two-wire, RS-485 four-wire |
| RS-232 lines supported | TD, RD, RTS, CTS, DTR, DSR, DCD, GND |
| RS-422/485 lines (4-wire) | TDA(-), TDB(+), RDA(-), RDB(+), GND |
| RS-485 lines (2-wire) | DATA A(-), DATA B(+), GND |
| RS-422/485 HS loopback | Loop back RTS to CTS, DTR to DSR/DCD |
| Baud rate (kbps) | 300, 600, 1200, 1800, 2400, 4800, 7200, 9600, 14400, 19200, 38400, 57600, 115200, 230400, 460800, 921600 |
| Data bits | 5, 6, 7, 8 |
| Parity | none, odd, even |
| Stop bit(s) | 0, 1, 2 |
| Switches | Quad DIP switch for user hardware selectibility per port |
| Driver | WHQL |
| Power supply requirement | 10VDC to 48VDC |
| Power supply connectors | Three position removable terminal block, threaded barrel jack with center + |
| Operating temperature | -40C to 80C |
| Storage temperature | -40C to 85C |
| Humidity | 5% to 90% non-condensing |
| LED indicators | Power - continuously on if powered via external supply or USB bus Four communication LEDs: P1 TX, P1 RX, P2 TX, P2 RX - green, blink when data present |
| Enclosure mounting | DIN adapter, Panel mounting with mounting kit |
| Accessories | Power supply: 12 VDC wall plug Cables: USB cable included with product Mounting: DIN adapter included on enclosure |

Certifications

| Category | Specification |
|-----------------|--|
| Emissions | FCC Class B, CISPR Class B (EN55022) |
| CE | EN61000-6-2:2005 – Heavy Industrial |
| | EN61000-4-2:2008 – (ESD) ±8kV contact, ±15kV air |
| | EN61000-4-3:2006 – (RI) 10V/m, 80 to 1000 MHz; 3 V/m, 1.3 to 2.7 GHz |
| | EN61000-4-4:2004 – (EFT Burst) ±2kV DC ports; ±1kV signal ports |
| | EN61000-4-5:2005 – (Surge) ±1kV Signal Ports |
| | EN61000-4-6:2005 – (CI) 10 VRMS , 0.15 to 80 MHz |
| Shock | EN61000-4-8:2001 – (Magnetic) 10A/m, 50 Hz and 60 Hz |
| | IEC60068-2-27 – 50G peak, 11ms, 3 axis |
| Vibration | IEC60068-2-6 – 10 to 500 Hz, 4G, 3 axis |
| Freefall (drop) | IEC60068-2-32 – 10 total drops from sides, corner and edges; 1M |

| Information – FCC rules |
|---|
| <p>This device complies with Part 15 of the FCC rules. Operation is subject to the following two conditions: CE</p> <p>(1) This device may not cause harmful interference.</p> <p>(2) This device must accept any interference that may cause undesired operation.</p> |
| Information – UL Class 1 Div 2 |
| <p>Suitable for use in Class 1, Division 2, Groups A, B, C and D Hazardous Locations, or Nonhazardous locations only.</p> <p>WARNING - EXPLOSION HAZARD – DO NOT DISCONNECT EQUIPMENT WHILE THE CIRCUIT IS LIVE UNLESS THE AREA IS KNOWN TO BE FREE OF IGNITABLE CONCENTRATIONS.</p> <p>Install in accordance with control drawing number 9340R0.</p> <p>Ind. Cont. Eq. For HAZ LOC 3HTV E245458 Class I, Div. 2, Groups A, B, C & D Temp. Code: T4A</p> <div style="text-align: right;">  </div> |

Default Settings

Basic Settings

| Category | Value |
|------------------|---------------------------------|
| Serial Interface | RS-232 (both DIP switches off) |
| Bits per second | 9600 |
| Data bits | 8 |
| Parity | None |
| Stop Bits | 1 |
| Flow Control | None |
| COM Port | first available over COM port 4 |

Advanced Settings

| Category | Value |
|-------------------------------|------------------|
| USB Transfer Size - Receive | 4096 bytes (max) |
| USB Transfer Size - Transmit | 4096 bytes (max) |
| Latency Timer | 16 |
| Minimum Read Timeout | 0 |
| Minimum Write Timeout | 0 |
| Serial Enumerator | On |
| Serial Printer | Off |
| Cancel If Power Off | Off |
| Event On Surprise Removal | Off |
| Set RTS On Close | Off |
| Disable Modem Ctrl At Startup | Off |

USR602 Dimensions

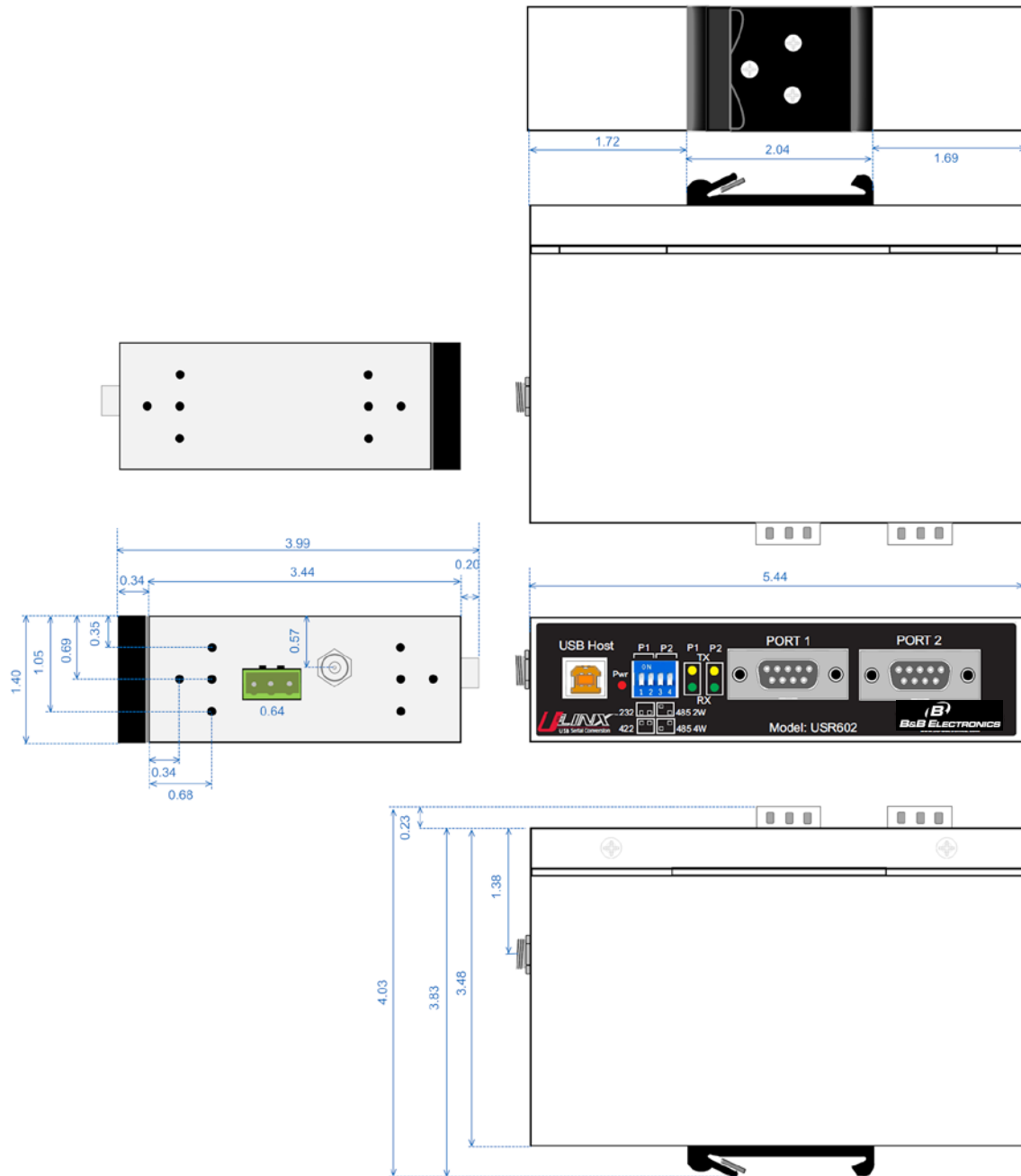

Figure 19: USR602 Dimensional Diagram

USR604 Dimensions

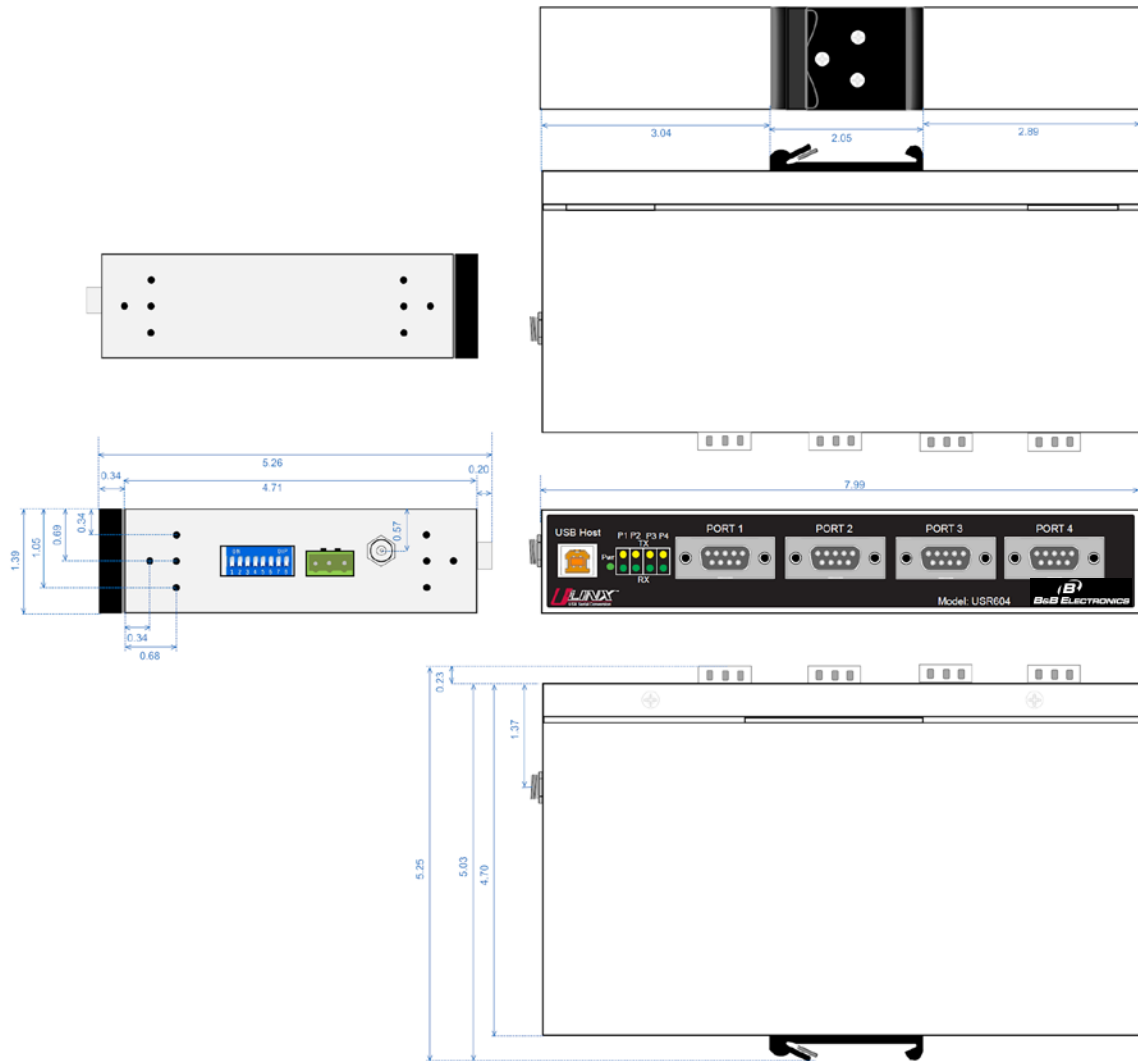

Figure 20: USR604 Dimensional Diagram

Panel Mount Dimensions

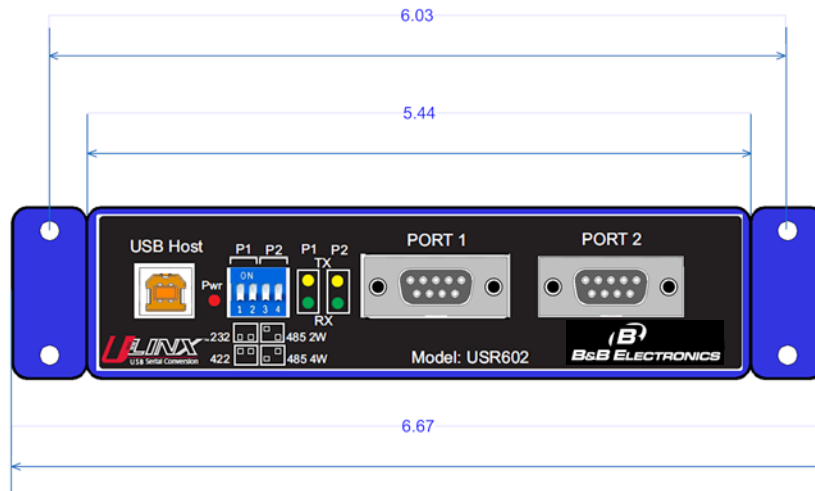

Figure 21: USR602 Panel Mount Dimensions

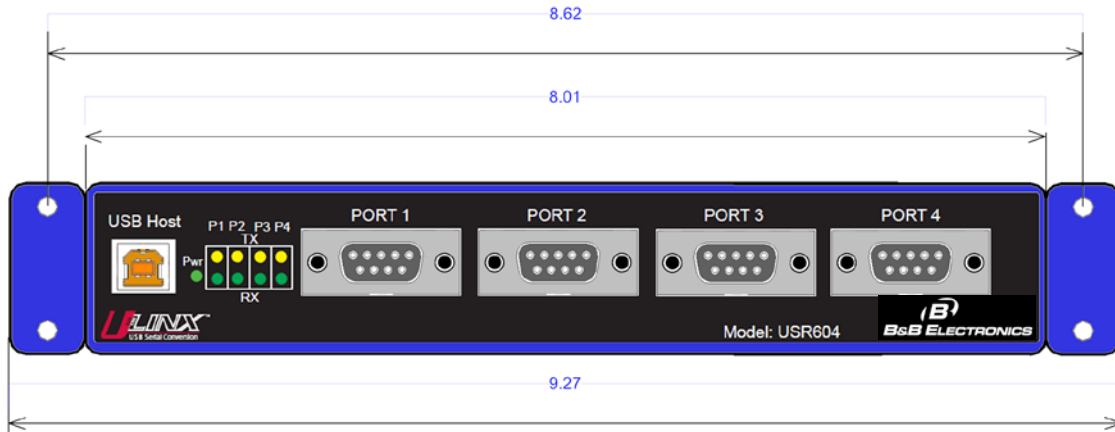

Figure 22: USR604 Panel Mount Dimensions

SECTION 8

Appendix

In This Section

Loopback Test
Serial Port Wiring

Loopback Test

To verify the operation of the USB to serial converter perform a loopback test using the following procedure:

1. Connect the converter to the PC with a USB cable and install the driver using the procedure provided in the Software Installation (on page 13) section of this manual.
2. On the PC open HyperTerminal (found in the Program files under Accessories / Communications).

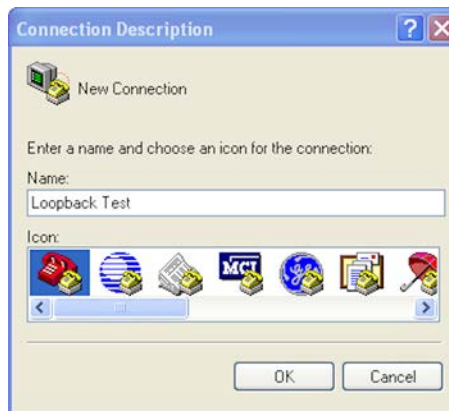

Figure 23: Hyperterminal Connection Name

3. Enter a connection name and click OK.



Figure 24: Selecting the COM Port

4. On the Connection using: dropdown list, select the port on the converter to be tested.
5. Click OK.

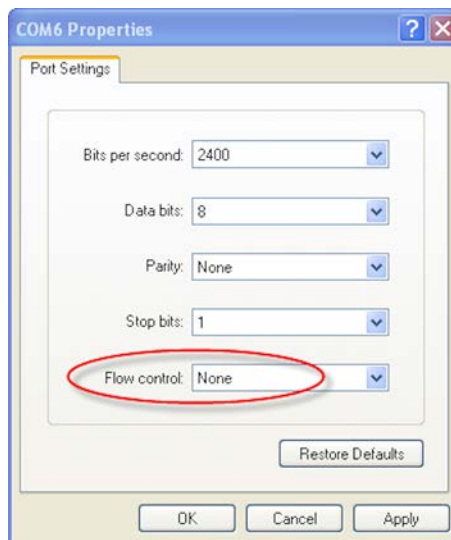
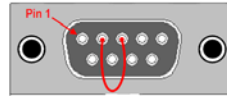

Figure 25: Setting the Port Settings

6. On the Properties / Port Settings dialog, ensure Flow control is set to None.
7. Click OK.

8. Set the serial port to RS-232 mode by switching both associated DIP switches to Off.
9. Plug a loopback plug into the DB9M connector associated with the serial port to be tested.



10. Type some characters on the PC's keyboard.
The characters should appear on the HyperTerminal window.

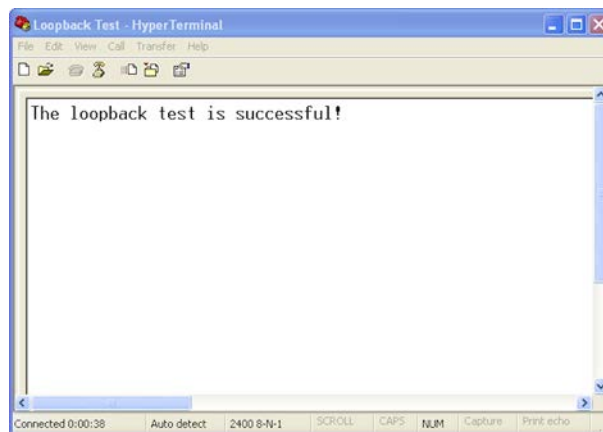

Figure 26: Successful Hyperterminal Port Test

11. Remove the loopback plug and type more characters.
No additional characters should appear on the HyperTerminal window.

Serial Port Wiring

RS-232 Connections

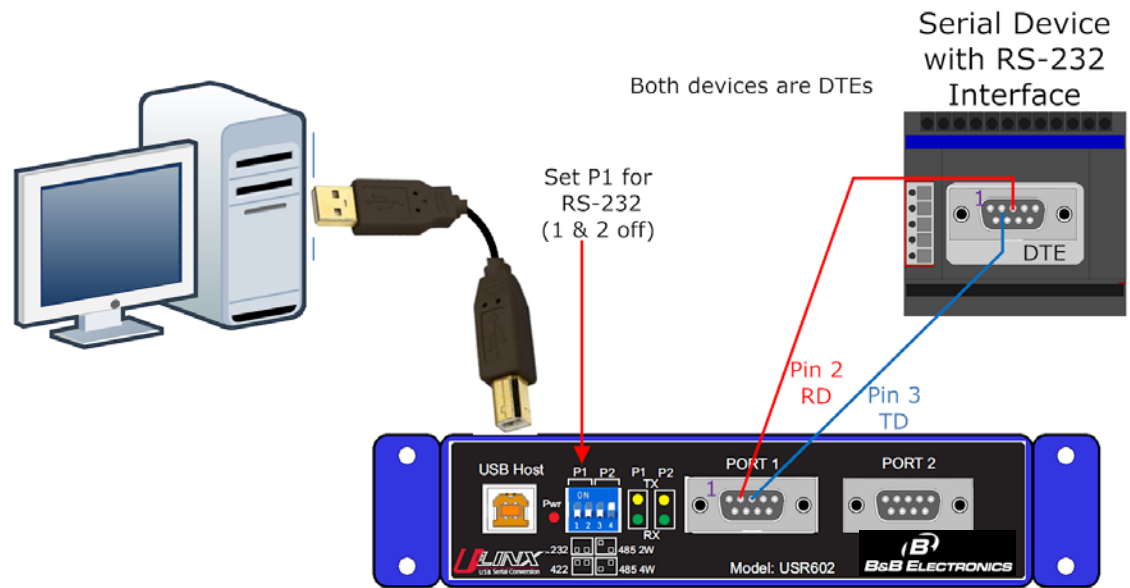

Figure 27: USB602 RS-232 Connections

RS-485 Two-Wire Connections

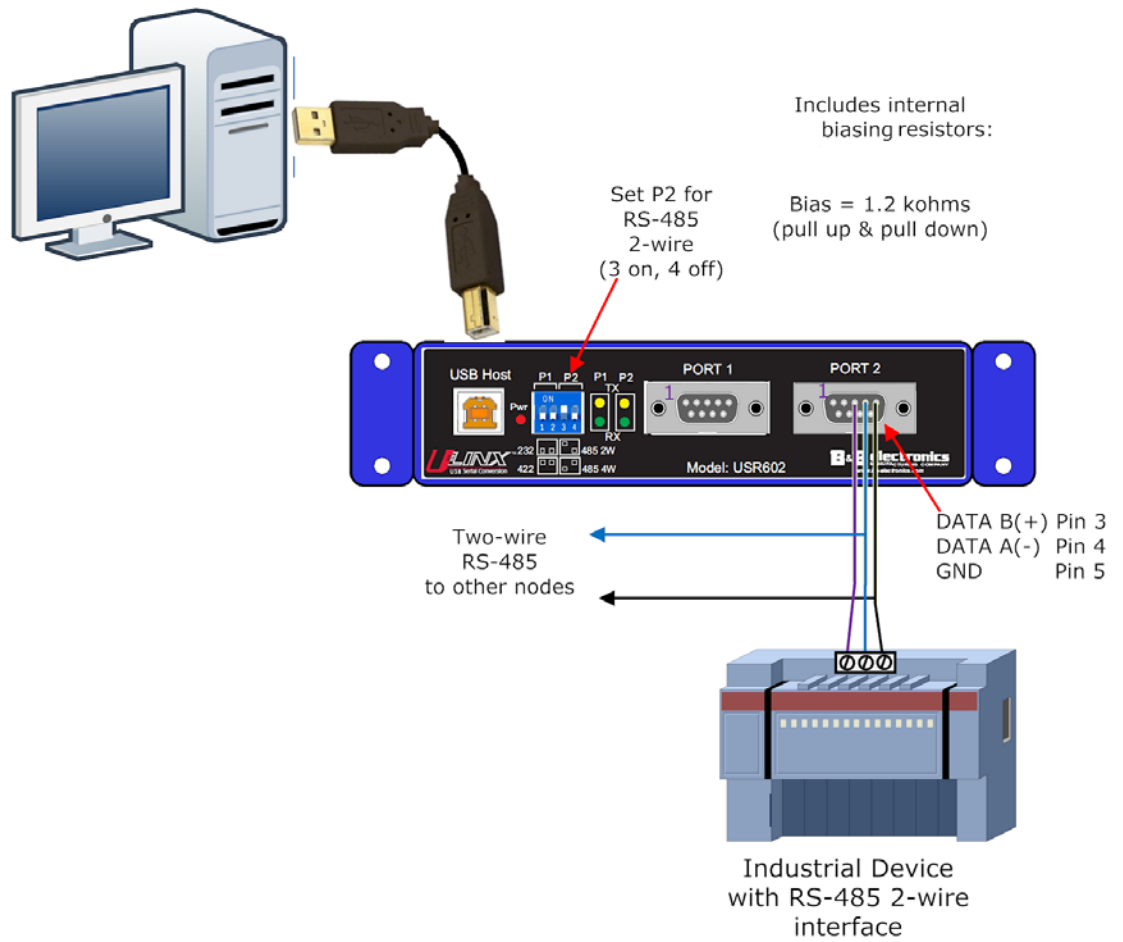

Figure 28: USB602 RS-485 Two-Wire Connections

RS-422 and RS-485 Four-Wire Connections

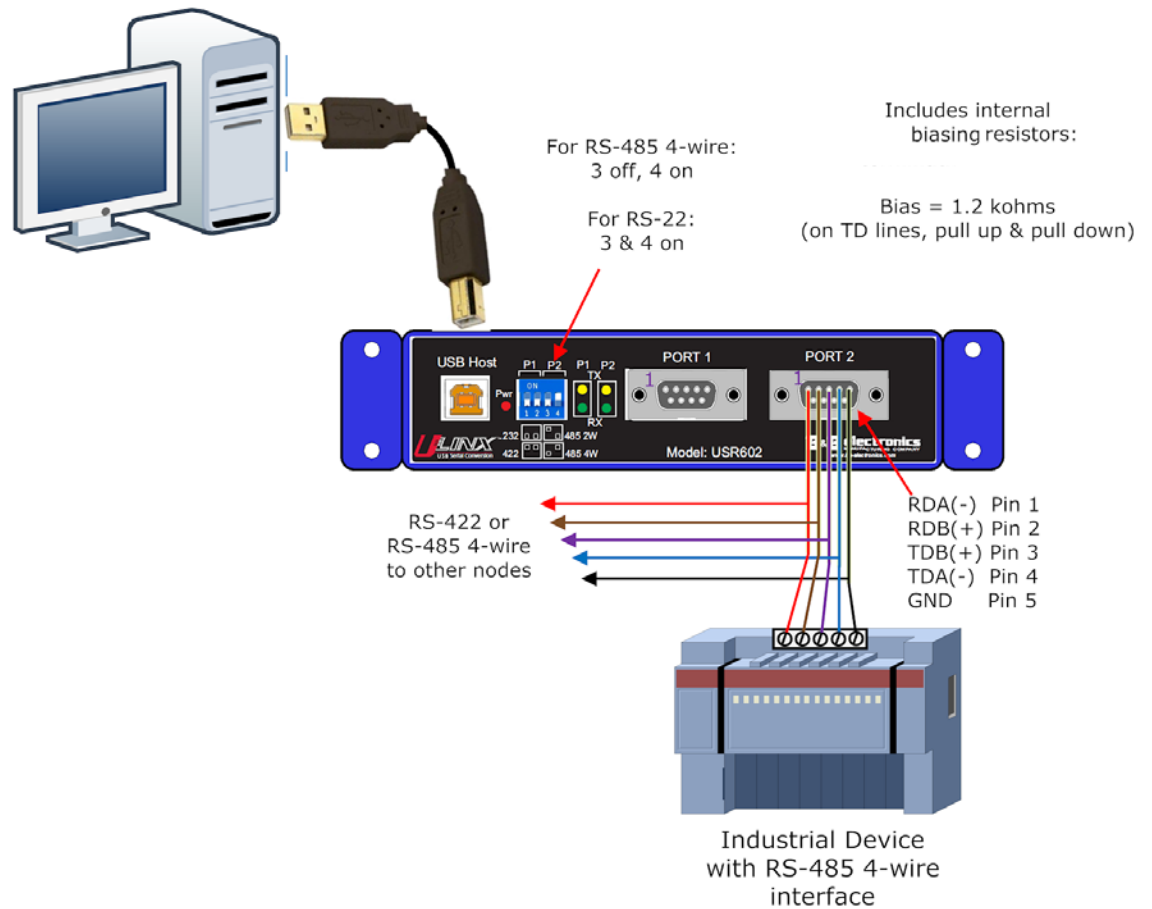

Figure 29: USR602 RS-422/485 Four-Wire Connections

Index

A

- About this Manual • 4
- Advanced Settings in Device Manager • 8, 23
- Advanced User Settings • 21
- Appendix • 35

B

- BM Options • 24

C

- Certifications • 29
- COM Port Number • 23
- Connecting Power • 7, 14
- Connecting to a PC • 15
- Connecting to the Serial Ports • 8, 16

D

- Default Settings • 30

H

- Hardware Installation • 13

I

- Installing and Mounting the USR60x • 14
- Installing the Driver • 7, 9

L

- LED Indicators • 7, 20
- Loopback Test • 8, 35

M

- Miscellaneous Options • 24
- Modbus Basics • 26

O

- Overview • 3

P

- Package Contents • 5
- Panel Mount Dimensions • 33
- Product Feature Summary • 4
- Product Information • 5
- Product Specifications • 27

Q

- Quick Start Guide • 7

R

- RS-232 Connections • 38
- RS-422 and RS-485 Four-Wire Connections • 8, 40
- RS-485 Two-Wire Connections • 8, 39

S

- Safety • 4
- Serial Port Wiring • 38
- Setting COM Port Operating Modes • 8, 18
- Setting Serial Port Properties • 22
- Software Installation • 9, 35
- Specifications • 27

T

- Termination and Biasing • 17
- Timeouts • 24
- Typical Applications / Modes of Operation • 6

U

- Un-Installing the Driver • 11
- USB Transfer Sizes • 23
- USR602 Dimensions • 31
- USR604 Dimensions • 32
- USR60x Models • 5