

DESCRIPTION: COAXIAL / SIGNAL - SOLDER CUP - FEMALE

SPECIFICATIONS:

ELECTRICAL:

INSULATOR RESISTANCE: 5,000 MegOHMS Min.
 DIELECTRIC WITHSTANDING: 1,000VAC r.m.s.
 OPERATING TEMPERATURE: -55° C ~ +125° C
 CONTACT RESISTANCE: 30 MilliOHMS Max.
 COAXIAL PINS: 50 OHM
 SIGNAL PINS: 3 AMPS

MECHANICAL:

CONTACT INSERTION FORCE: 4.5 Kg Max.
 CONTACT SEPARATOR FORCE: 0.3Kg Min.

MATERIALS:

CONTACTS: BRASS
 INSULATOR: PBT UL94V-0 RATED,
 230°C PROCESS TEMP.
 STEEL
 SHELL:
 FINISH:
 SHELL: NICKEL

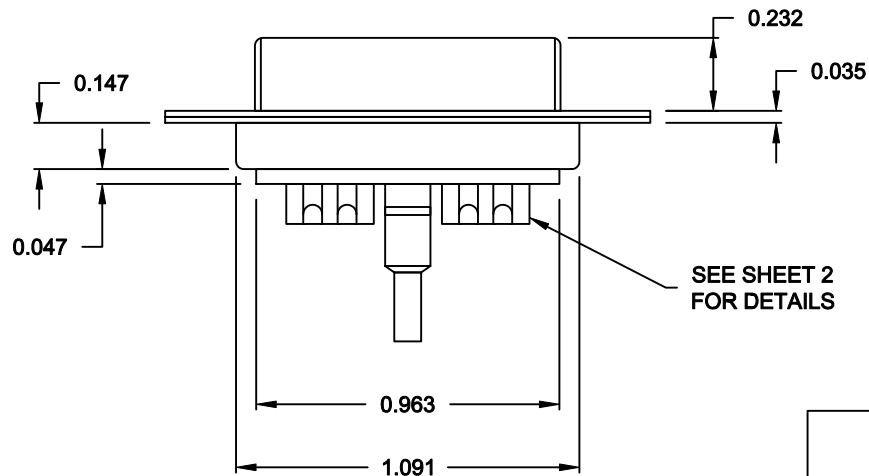
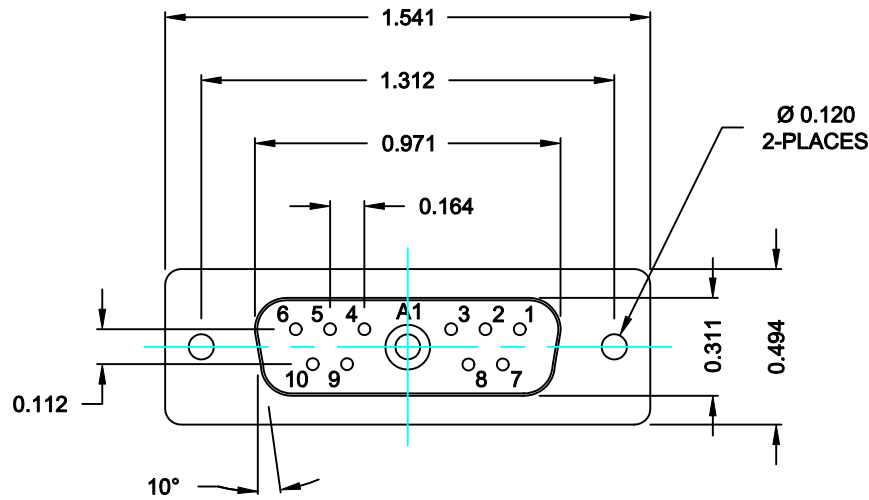

68211W1203L001

00 = 50 OHM COAXIAL

RoHS COMPLIANT

	THESE DRAWINGS AND SPECIFICATIONS ARE THE PROPERTY OF NorComp AND SHALL NOT BE REPRODUCED, COPIED OR USED AS THE BASIS FOR THE MANUFACTURE OF SALE OF APPARATUS WITHOUT WRITTEN PERMISSION.		DRAWN: C. SMITH	DATE: 09-21-06
			CHECKED: X	DATE: X
NorComp		SCALE: N.T.S.	SHEET 1 OF 2	REV 2
		DWG NO. 68211W1203L001		

NOTE:
 SIGNAL CONTACTS COME PRE-LOADED INTO INSULATORS.
 COAXIAL CONTACTS SUPPLIED - NOT PRE-LOADED.

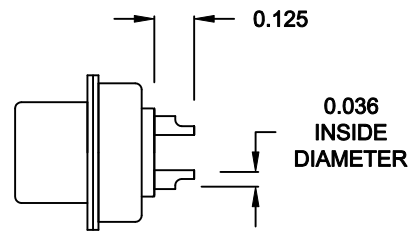

SIGNAL CONTACTS
 ACCEPTS UP TO 20 AWG WIRE

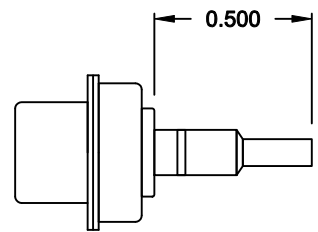

COAXIAL CONTACT
 ACCEPTS 50 OHM COAX, RG316/RG174

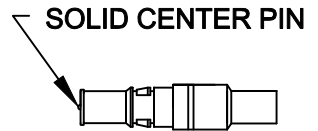

FEMALE COAXIAL CONTACT

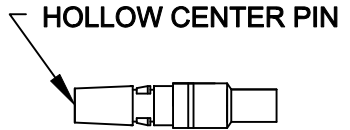

MALE COAXIAL CONTACT

RoHS COMPLIANT

	THESE DRAWINGS AND SPECIFICATIONS ARE THE PROPERTY OF NorComp AND SHALL NOT BE REPRODUCED, COPIED OR USED AS THE BASIS FOR THE MANUFACTURE OF SALE OF APPARATUS WITHOUT WRITTEN PERMISSION.		DRAWN: C. SMITH	DATE: 09-21-06
			CHECKED: X	DATE: X
<h1>NorComp</h1>		SCALE: N.T.S.	SHEET 2 OF 2	REV 2
		DWG NO. 68211W1203L001		