

4.5 mm×2.2 mm Side-operational Edge Mount

Light Touch Switches

Type: **EVPAE**

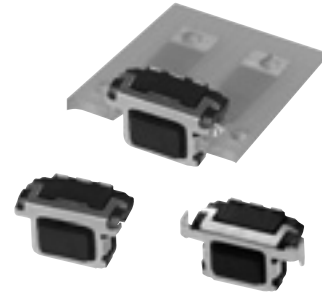

■ Features

- External dimensions : 4.5 mm×2.25 mm (Excluding the push plate), Height 2.9 mm (Printed circuit board being as low as 0.95 mm)
- Improved soldering strength in the operating direction
- Long operational life
- Measure against electro static discharge(ESD)

■ Recommended Applications

- Operation switches for portable electronic equipment (Mobile phones, Digital still cameras, Camcorders, Portable audio players, etc.)

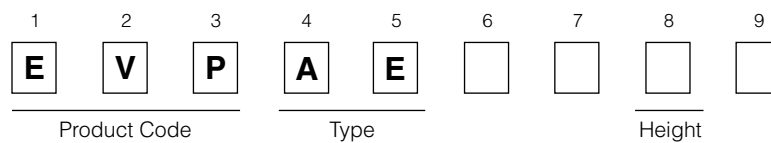

■ Explanation of Part Numbers



■ Specifications

Type		Snap action / Push-on type SPST
Electrical	Rating	10 μA 2 Vdc to 20 mA 15 Vdc (Resistive load)
	Contact Resistance	1000 mΩ max.
	Insulation Resistance	100 MΩ min. (at 100 Vdc)
	Dielectric Withstanding Voltage	250 Vac (1 minute)
	Bouncing	10 ms max. (ON, OFF)
Mechanical	Operating Force	1.6 N, 3.0 N, 3.5 N
	Push Travel	1.6 N, 3.0 N, 3.5 N : 0.15 mm 1.6 N (With L-shape terminals) : 0.13 mm
	Push Strength	50 N (1 minute)
Endurance	Operating Life	200000 cycles min.
Operating Temperature		-40 °C to +85 °C
Storage Temperature		-40 °C to +85 °C (Bulk)
		-20 °C to +60 °C (Taping)
Minimum Quantity/Packing Unit		3500 pcs. Embossed Taping (Reel Pack)
Quantity/Carton		17500 pcs.

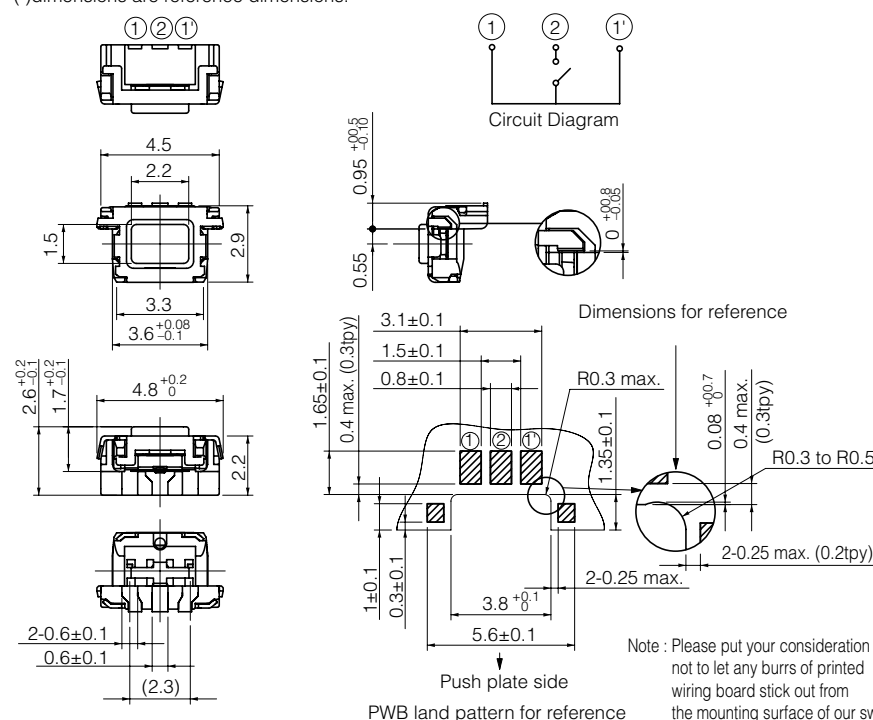
■ Dimensions in mm (not to scale)

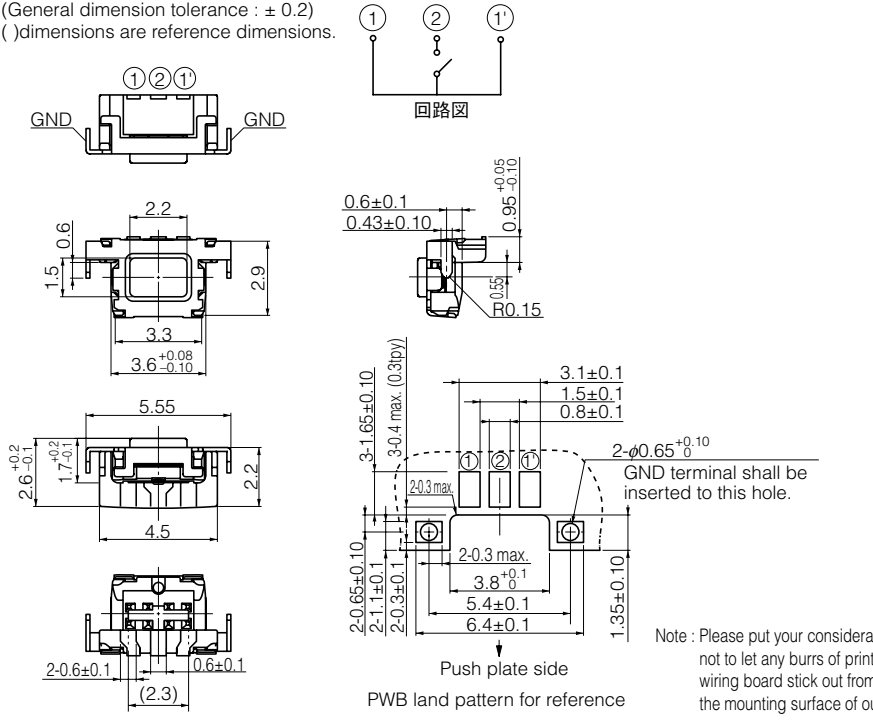
<p>No. 1</p> <p>EVPAE</p> <p>Edge Mount</p> 	<p>(General dimension tolerance : ± 0.2) () dimensions are reference dimensions.</p>  <p>Dimensions for reference</p> <p>Push plate side PWB land pattern for reference</p> <p>Note : Please put your consideration not to let any burrs of printed wiring board stick out from the mounting surface of our switches.</p> <p>* Height from surface of PCB : 0.95 mm</p>			
<p>Part Numbers</p>	<p>Operating Force</p>	<p>Height</p>	<p>Push Plate Color</p>	<p>Operating Life</p>
<p>EVPAEBB2A</p>	<p>1.6 N</p>	<p>0.95 mm</p>	<p>Black</p>	<p>200000 cycles</p>
<p>EVPAEDB2A</p>	<p>3.0 N</p>	<p>0.95 mm</p>	<p>Black</p>	<p>200000 cycles</p>
<p>EVPAEJB2A</p>	<p>3.5 N</p>	<p>0.95 mm</p>	<p>Black</p>	<p>200000 cycles</p>
<p>No. 2</p> <p>EVPAE</p> <p>With L-shape terminals</p> 	<p>(General dimension tolerance : ± 0.2) () dimensions are reference dimensions.</p>  <p>Dimensions for reference</p> <p>Push plate side PWB land pattern for reference</p> <p>Note : Please put your consideration not to let any burrs of printed wiring board stick out from the mounting surface of our switches.</p> <p>* Height from surface of PCB : 0.95 mm</p>			
<p>Part Numbers</p>	<p>Operating Force</p>	<p>Height</p>	<p>Push Plate Color</p>	<p>Operating Life</p>
<p>EVPAEGE2A</p>	<p>1.6 N</p>	<p>0.95 mm</p>	<p>Black</p>	<p>200000 cycles</p>

Recommended Reflow Soldering Conditions

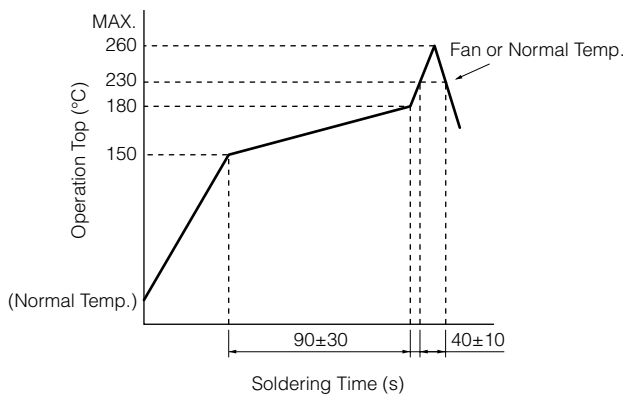

Embossed Carrier Taping

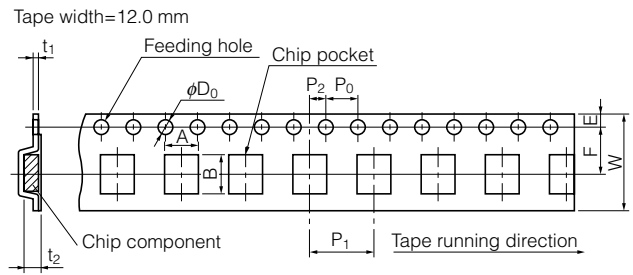

Unit: mm

Part No.	Height	A	B	W	F	E	P ₁	P ₂	P ₀	D ₀ Dia	t ₁	t ₂
EVPAE	2.9	5.5±0.2	2.9±0.2	12.0±0.3	5.5±0.1	1.75±0.10	8.0±0.1	2.0±0.1	4.0±0.1	1.5 ^{+0.1} ₀	0.3±0.1	3.3±0.20

With L-shape terminals

Unit: mm

Part No.	Height	A	B	W	F	E	P ₁	P ₂	P ₀	D ₀ Dia	t ₁	t ₂
EVPAE	2.9	6.1±0.2	2.9±0.2	12.0±0.3	5.5	1.75±0.10	8.0±0.1	2.0±0.1	4.0±0.1	1.5 ^{+0.1} ₀	0.3±0.1	3.3±0.20

Standard Reel Dimensions in mm (not to scale)

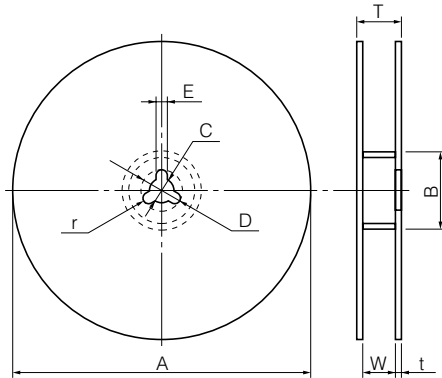

Item	A	B	C	D	E
Rate (mm)	φ380.0±2.0	φ80.0±1.0	φ13.0±0.5	φ21.0±1.0	2.0±0.5

Item	W	T	t	r
Rate (mm)	13.5±1.0	17.5±1.0	—	—