

DESCRIPTION: M5 MALE - PANEL MOUNT (REAR) - VERTICAL - 4 POSITION

NOTE:

MATERIAL	
HOUSING:	PBT UL94V-0, BLACK
CONTACT:	BRASS
NUT:	BRASS
SHELL:	BRASS
O-RING:	NBR, BLACK
FINISH	
CONTACT:	GOLD FLASH (0.8-1.0) μ m OVER 50 μ m NICKEL NICKEL PLATED NICKEL PLATED
ELECTRICAL	
RATED CURRENT:	1A
RATED VOLTAGE:	60V
WATER PROOF:	IP67
ENVIRONMENT	
OPERATION TEMPERATURE:	-40°C TO +85°C

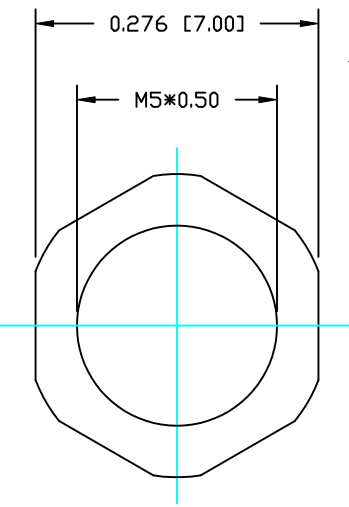
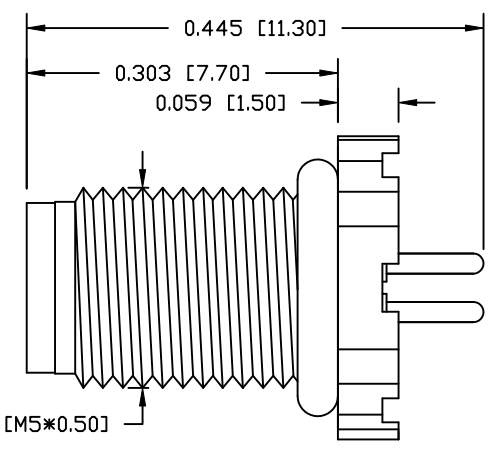
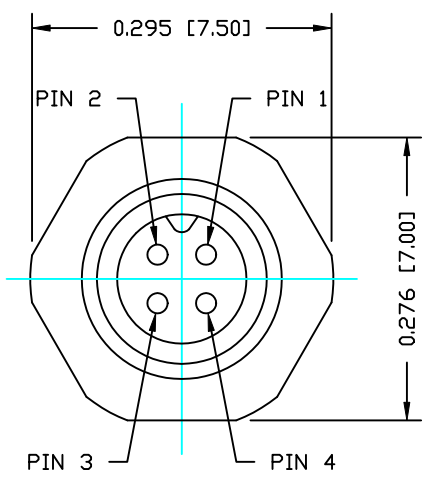

NUT

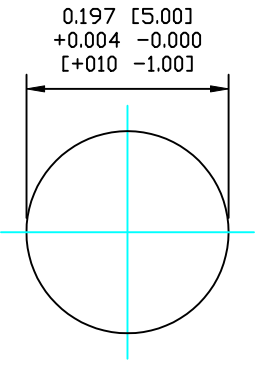
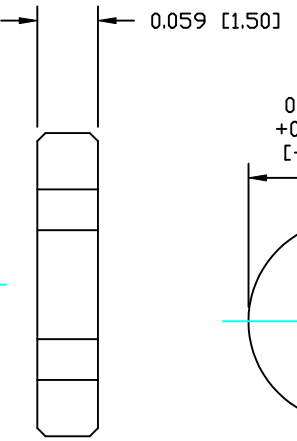

RECOMMENDED
PANEL CUTOUT

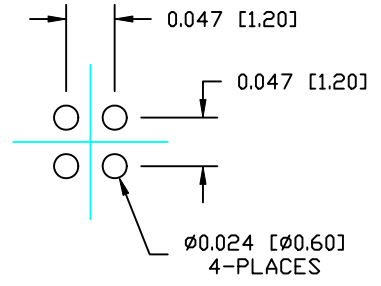

RECOMMENDED
PANEL PCB

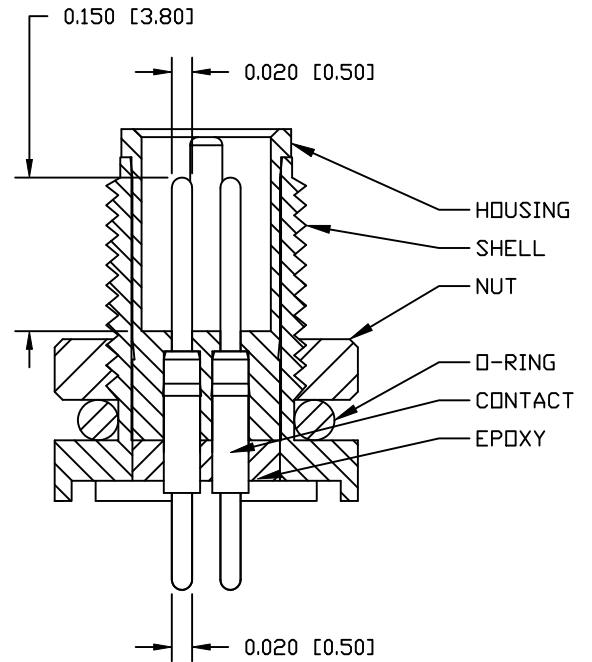

RoHS COMPLIANT

DO NOT SCALE FROM DRAWING



THESE DRAWINGS AND SPECIFICATIONS ARE THE PROPERTY OF NorComp AND SHALL NOT BE REPRODUCED, COPIED OR USED AS THE BASIS FOR THE MANUFACTURE OR SALE OF APPARATUS WITHOUT WRITTEN PERMISSION.

DRAWN:
C. SMITH

DATE:
08/17/14

CHECKED:

DATE:

NorComp

SCALE:
NTS

SHEET **1** OF **1**

REV **0**

DWG NO. **852-004-113R001**