

## WIDEBAND POWER AMPLIFIER MODULE, 0.01 - 15 GHz



### Typical Applications

The HMC-C036 Wideband PA is ideal for:

- Telecom Infrastructure
- Microwave Radio & VSAT
- Military & Space
- Test Instrumentation
- Fiber Optics

### Functional Diagram

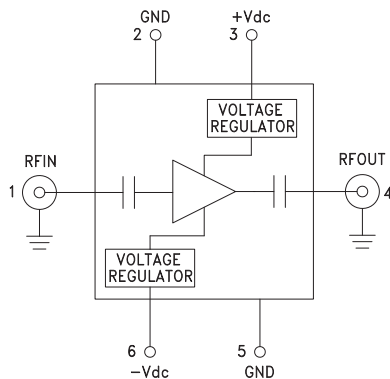

### Features

- Gain: 12 dB
- P1dB Output Power: +28 dBm
- Regulated Supply and Bias Sequencing
- Hermetically Sealed Module
- Field Replaceable SMA connectors
- 0 °C to +85 °C Operating Temperature

### General Description

The HMC-C036 is a GaAs MMIC PHEMT Power Amplifier in a miniature, hermetic module with replaceable SMA connectors which operates between 0.01 GHz and 15 GHz. The amplifier provides 12 dB of gain, up to +36 dBm output IP3 and up to +28 dBm of output power at 1 dB gain compression. Gain flatness is excellent from 2 - 12 GHz making the HMC-C036 ideal for EW, ECM RADAR, Fiber Optic and test equipment applications. The wideband amplifier I/Os are internally matched to 50 Ohms and are DC blocked. Integrated voltage regulators allow for flexible biasing of both the negative and positive supply pins, while internal bias sequencing circuitry assures robust operation.

### Electrical Specifications, $T_A = +25^\circ\text{C}$ , +Vdc = +11V to +16V, -Vdc = -3V to -12V

Parameter	Min.	Typ.	Max.	Min.	Typ.	Max.	Min.	Typ.	Max.	Units
Frequency Range	0.5 - 6.0			6.0 - 12.0			12.0 - 15.0			GHz
Gain	9.5	12.5		9	12		8	11		dB
Gain Flatness		±0.3			±0.3			±0.6		dB
Gain Variation Over Temperature		0.02			0.02			0.02		dB/ °C
Noise Figure		4.5			4.5			7.0		dB
Input Return Loss		22			11			4		dB
Output Return Loss		13			12			10		dB
Output Power for 1 dB Compression (P1dB)	25	28		23	26		23	26		dBm
Saturated Output Power (Psat)		29			27			28		dBm
Output Third Order Intercept (IP3)		36			34			32		dBm
Positive Supply Current (+IDC)		360			360			360		mA
Negative Supply Current (-IDC)		-5.5			-5.5			-5.5		mA

# HMC-C036\* PRODUCT PAGE QUICK LINKS

Last Content Update: 02/23/2017

---

## COMPARABLE PARTS

View a parametric search of comparable parts.

## DOCUMENTATION

### Application Notes

- AN-1363: Meeting Biasing Requirements of Externally Biased RF/Microwave Amplifiers with Active Bias Controllers

### Data Sheet

- HMC-C036 Data Sheet

## TOOLS AND SIMULATIONS

- HMC-C036 S-Parameter

## DESIGN RESOURCES

- HMC-C036 Material Declaration
- PCN-PDN Information
- Quality And Reliability
- Symbols and Footprints

## DISCUSSIONS

View all HMC-C036 EngineerZone Discussions.

## SAMPLE AND BUY

Visit the product page to see pricing options.

## TECHNICAL SUPPORT

Submit a technical question or find your regional support number.

## DOCUMENT FEEDBACK

Submit feedback for this data sheet.

---



**WIDEBAND POWER AMPLIFIER  
MODULE, 0.01 - 15 GHz**

**Gain & Return Loss**

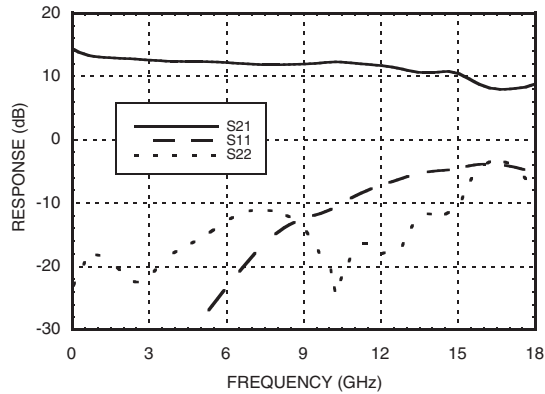

**Gain vs. Temperature**

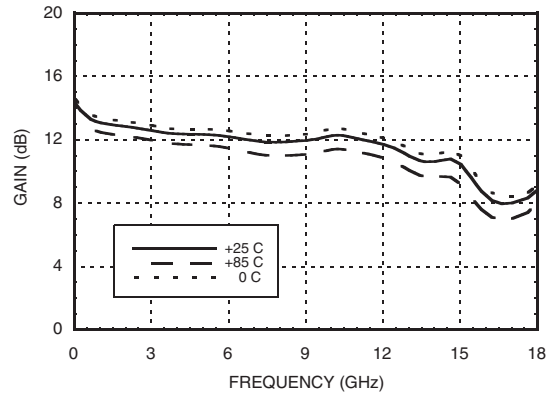

**Input Return Loss vs. Temperature**

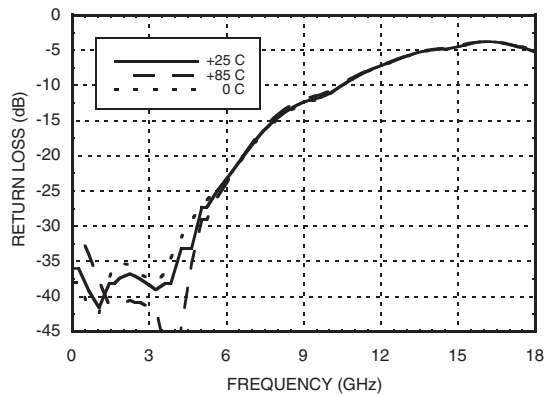

**Output Return Loss vs. Temperature**

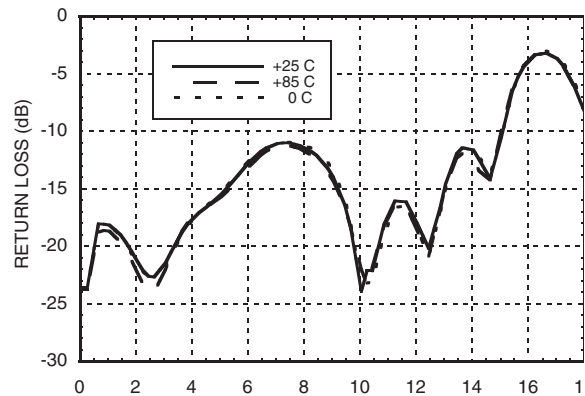

**Reverse Isolation vs. Temperature**

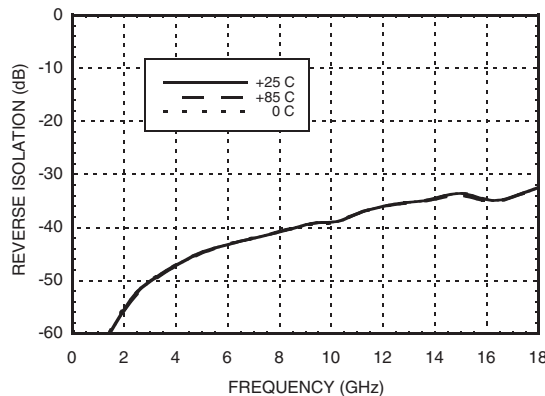

**Noise Figure vs. Temperature**

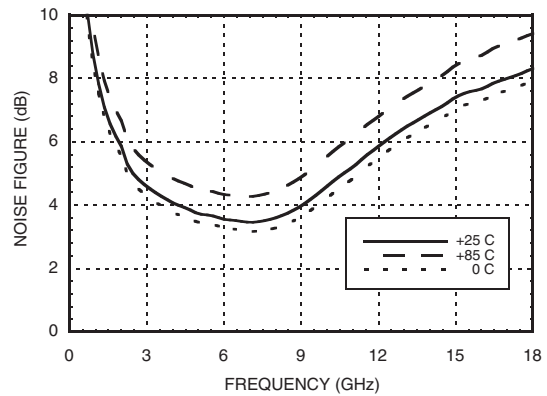

Information furnished by Analog Devices is believed to be accurate and reliable. However, no responsibility is assumed by Analog Devices for its use, nor for any infringements of patents or other rights of third parties that may result from its use. Specifications subject to change without notice. No license is granted by implication or otherwise under any patent or patent rights of Analog Devices. Trademarks and registered trademarks are the property of their respective owners.

For price, delivery, and to place orders: Analog Devices, Inc., One Technology Way, P.O. Box 9106, Norwood, MA 02062-9106 Phone: 781-329-4700 • Order online at [www.analog.com](http://www.analog.com) Application Support: Phone: 1-800-ANALOG-D



**WIDEBAND POWER AMPLIFIER  
MODULE, 0.01 - 15 GHz**

**P1dB vs. Temperature**

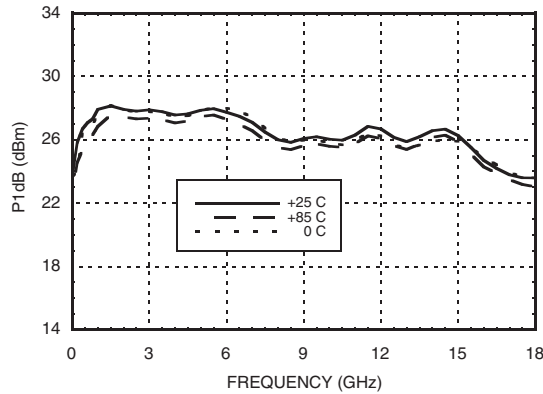

**Psat vs. Temperature**

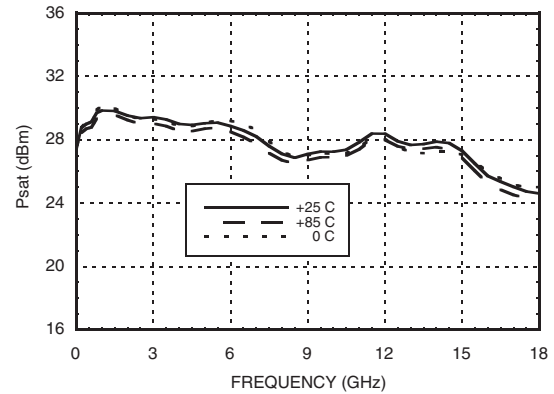

**Output IP3 vs. Temperature**

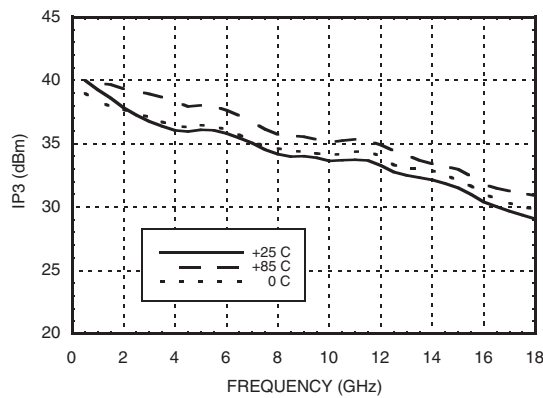

**Group Delay**

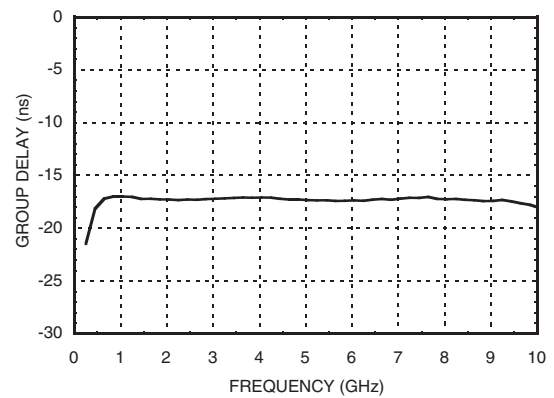

**Deviation from Linear Phase**

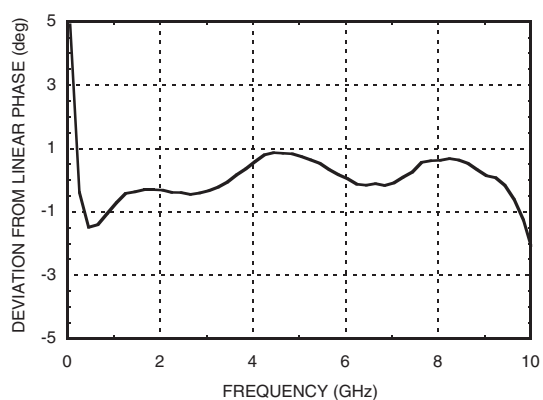

**Low Frequency Gain & Return Loss**

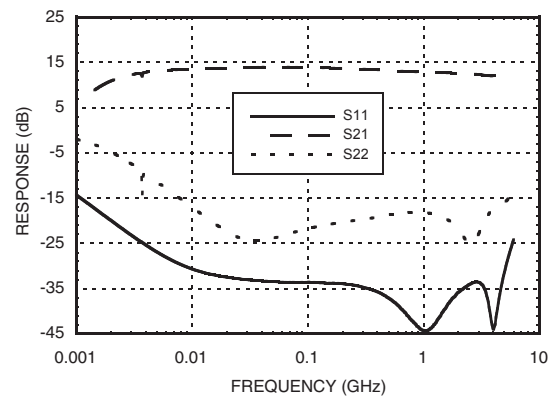

Information furnished by Analog Devices is believed to be accurate and reliable. However, no responsibility is assumed by Analog Devices for its use, nor for any infringements of patents or other rights of third parties that may result from its use. Specifications subject to change without notice. No license is granted by implication or otherwise under any patent or patent rights of Analog Devices. Trademarks and registered trademarks are the property of their respective owners.

For price, delivery, and to place orders: Analog Devices, Inc., One Technology Way, P.O. Box 9106, Norwood, MA 02062-9106 Phone: 781-329-4700 • Order online at [www.analog.com](http://www.analog.com) Application Support: Phone: 1-800-ANALOG-D

## WIDEBAND POWER AMPLIFIER MODULE, 0.01 - 15 GHz



### Absolute Maximum Ratings

Positive Bias Supply Voltage (+Vdc)	+17V Max
Negative Bias Supply (-Vdc)	-16V Min.
Maximum RF Input Power	
Peak	24 dBm
CW @ 0.01 - 6 GHz	22 dBm
CW @ 6 - 12 GHz	21 dBm
CW @ 12 - 20 GHz	18 dBm
Storage Temperature	-65 to +150 °C
Operating Temperature	0 to +85 °C



ELECTROSTATIC SENSITIVE DEVICE  
OBSERVE HANDLING PRECAUTIONS

### Pin Descriptions

Pin Number	Function	Description	Interface Schematic
1	RFIN & RF Ground	RF input connector, SMA female, field replaceable. This pin is AC coupled and matched to 50 Ohms.	
2, 5	GND	Power supply ground.	
3	+Vdc	Positive power supply voltage for the amplifier.	
4	RFOUT & RF Ground	RF output connector, SMA female. This pin is AC coupled and matched to 50 Ohms.	
6	-Vdc	Negative power supply voltage for the amplifier	



**WIDEBAND POWER AMPLIFIER  
MODULE, 0.01 - 15 GHz**

1

AMPLIFIERS

**Outline Drawing**

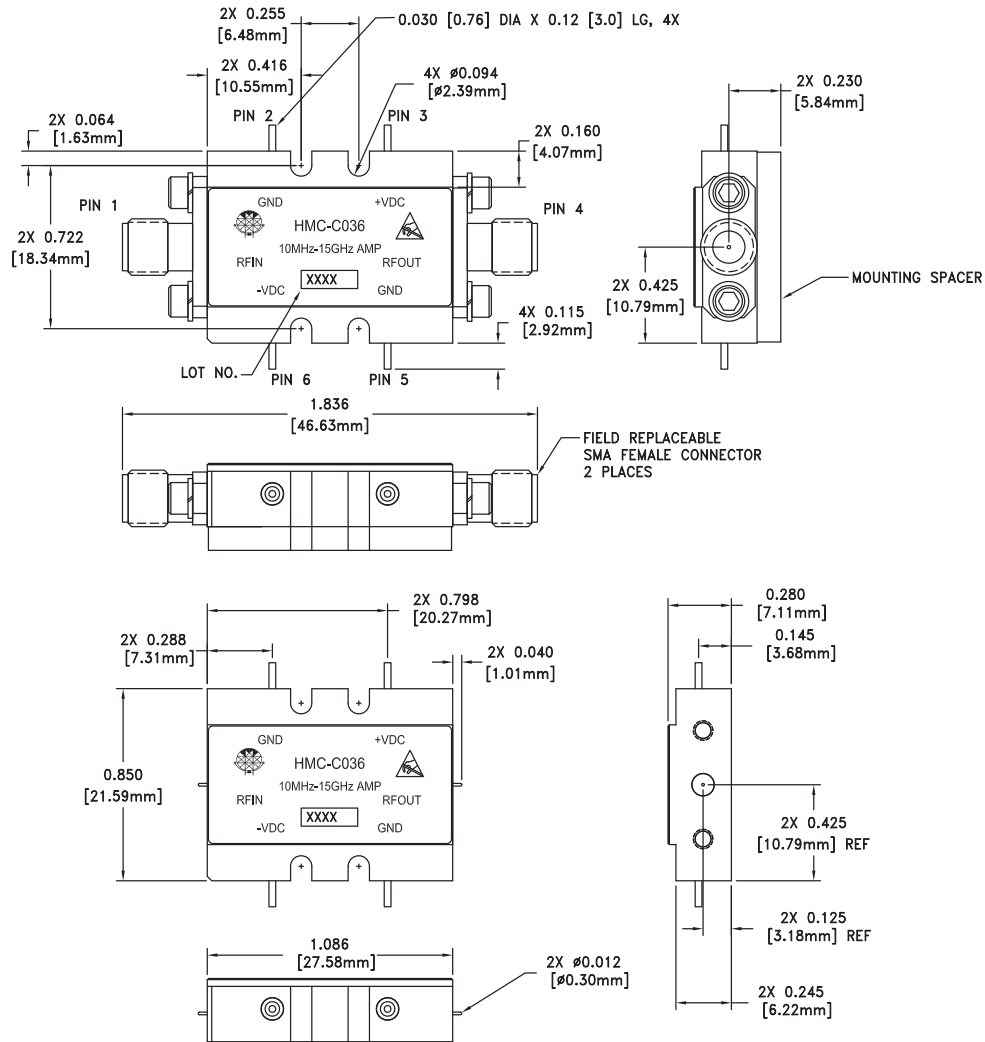

VIEW SHOWN WITH CONNECTORS REMOVED

**Package Information**

Package Type	C-10B
Package Weight [1]	23.1 gms [2]
Spacer Weight	N/A

[1] Includes the connectors  
[2] ±1 gms Tolerance

**NOTES:**

1. PACKAGE, LEADS, COVER MATERIAL: KOVAR™
2. FINISH: GOLD PLATE OVER NICKEL PLATE
3. ALL DIMENSIONS ARE IN INCHES [MILLIMETERS]
4. TOLERANCES:  
4.1 .XX = ±0.02  
4.2 .XXX = ±0.010
5. FIELD REPLACEABLE 2.92mm CONNECTORS  
TENSOLITE 231CCSF OR EQUIVALENT

**WIDEBAND POWER AMPLIFIER  
MODULE, 0.01 - 15 GHz****Notes:**