



VDC	600 V
Q _C	14 nC
I _F	6 A

Amp+™ Features

- High surge current capable
- Zero reverse recovery current
- High bandwidth
- Fast, temperature-independent switching

Amp+™ Benefits

- Unipolar rectifier
- Zero switching loss
- Higher efficiency
- Smaller heat sink
- Parallel devices with thermal stability

Amp+™ Applications

- Motor drives
- Switch mode power supplies
- Power factor correction

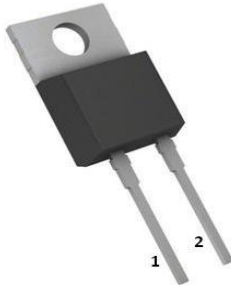

Part #	Package	Marking
GP2D006A060A	TO-220-2L	2D006A060



Maximum Rating	Symbol	Conditions	Value	Unit
Continuous forward current	I _F	T _C =25 °C, T _J =175 °C	18	A
		T _C =125 °C, T _J =175 °C	10	
		T _C =150 °C, T _J =175 °C	6	
Surge non-repetitive forward current sine halfwave	I _{F,SM}	T _C =25 °C, t _p =8.3 ms	48	A
		T _C =150 °C, t _p =8.3 ms	30	
Non-repetitive peak forward current	I _{F,max}	T _C =25 °C, t _p =10 μs	120	A
i ² t value	∫i ² dt	T _C =25 °C, t _p =8.3 ms	10	A ² s
		T _C =150 °C, t _p =8.3 ms	4	
Repetitive peak reverse voltage	V _{RRM}	T _J =25 °C	600	V
Diode dv/dt ruggedness	dv/dt	Turn-on slew rate, repetitive	50	V/ns
Power dissipation	P _{tot}	T _C =25 °C	65	W
Operating & storage temperature	T _J , T _{storage}	Continuous	-55...175	°C
Soldering temperature	T _{solder}	Wave soldering leads	260	°C
Mounting torque		M3 Screw	1	N-m

Electrical Characteristics, at T_J=25 °C, unless otherwise specified

Static Characteristics	Symbol	Conditions	Values			Unit
			min.	typ.	max.	
DC blocking voltage	V _{DC}	I _R =0.1mA	600	-	-	V
Diode forward voltage	V _F	I _F =6A, T _J =25 °C	-	1.45	1.65	
		I _F =6A, T _J =175 °C	-	1.65	2.00	
Reverse current	I _R	V _R =600V, T _J =25 °C	-	2.0	20	μA
		V _R =600V, T _J =175 °C	-	50	480	

600V SiC Schottky Diode

Amp+™

GP2D006A060A

Parameter	Symbol	Conditions	Values			Unit
			min.	typ.	max.	

AC Characteristics

Total capacitive charge	Q_C	$V_R=600V, T_j=25^\circ C$	-	14	-	nC
Switching time	t_c	$di_F/dt=200 A/\mu s$ $T_j=150^\circ C$	-	-	<10	ns
Total capacitance	C	$V_R=1 V, f=1 MHz$	-	316	-	pF
		$V_R=300V, f=1 MHz$	-	28	-	
		$V_R=600V, f=1 MHz$	-	23	-	

Thermal Characteristics

Thermal resistance, junction-case	R_{thJC}	Package (flange) mount	-	2.30	-	$^\circ C/W$
-----------------------------------	------------	------------------------	---	------	---	--------------

Typical Performance

Fig. 1 Forward Characteristics (parameterized on T_j)

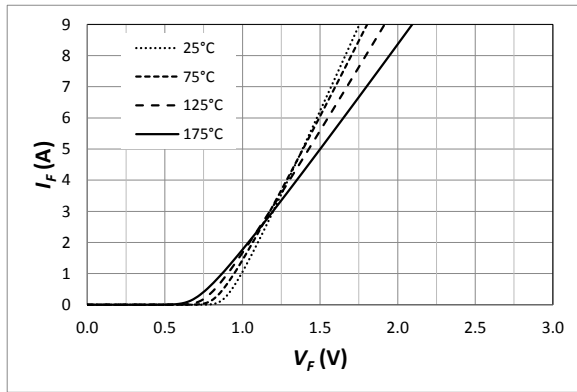

Fig. 2 Reverse Characteristics (parameterized on T_j)

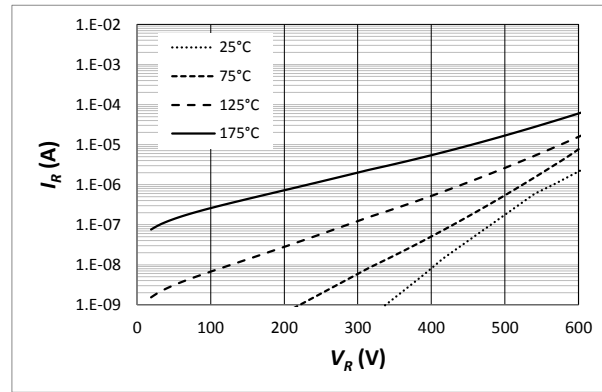

Fig. 3 Power Derating

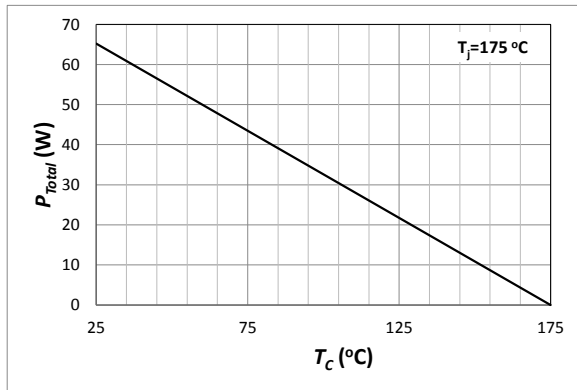

Fig. 4 Current Derating

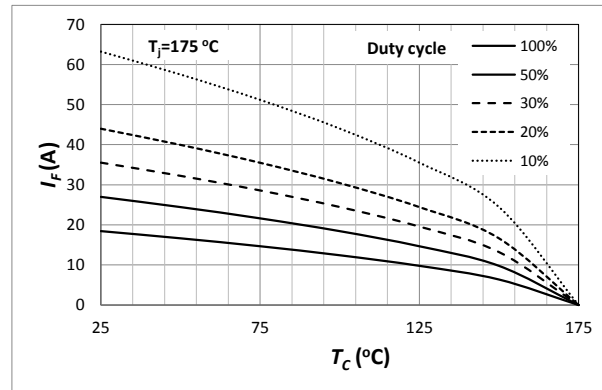

Fig. 5 Capacitance

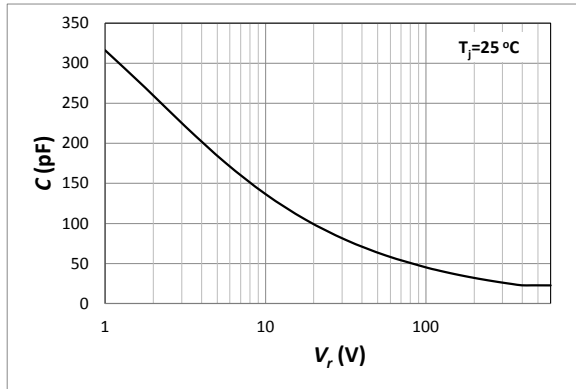
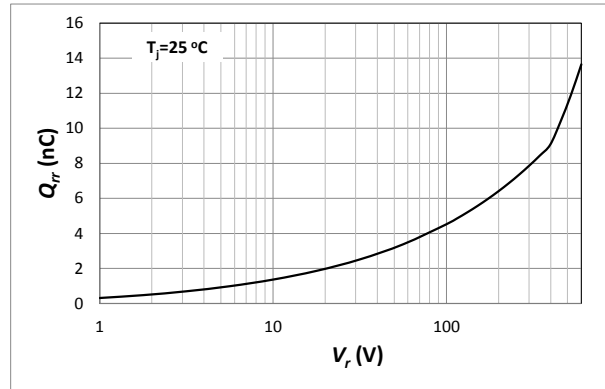

Fig. 6 Recovery Charge



Package Dimensions

Package TO-220-2L

TO-220-2L

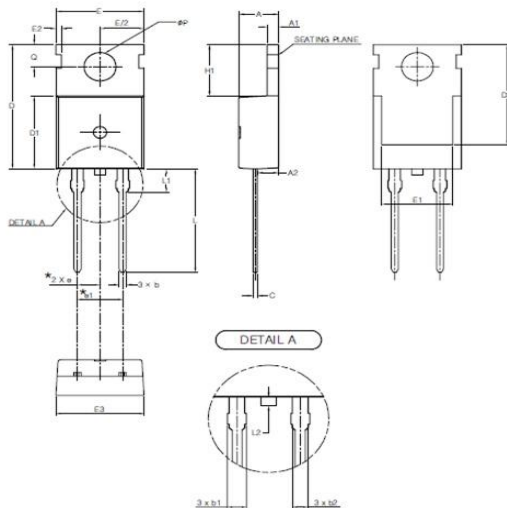

SYMBOL	MIN	NOM	MAX
A	4.30	4.50	4.70
A1	1.25	1.30	1.40
A2	2.20	2.40	2.60
b	0.70	0.80	0.90
b1	1.42	1.52	1.62
b2	1.17	1.27	1.37
c	0.45	0.50	0.60
D	15.50	15.70	15.90
D1	9.00	9.20	9.40
D2	(12.70)		
E	9.00	9.20	9.40
E1	(8.00)		
E2	(0.60)		
E3	9.70	9.90	10.10
e	2.54 BSC		
e1	5.08 BSC		
H1	6.30	6.50	6.70
L	12.88	13.08	13.28
L1	(3.00)		
L2	-	-	0.80
phi P	3.50	3.60	3.70
Q	2.70	2.80	2.90

NOTE

1. THESE DIMENSIONS DO NOT INCLUDE PROTRUSIONS OF THE MOLD.
2. THE "1" MARK IS THE REFERENCE
3. THE "L2" SYMBOL IS A PROTRUSION OF THE MOLD.

Note

RoHS Compliance

The levels of RoHS restricted materials in this product are below the maximum concentration values (also referred to as the threshold limits) permitted for such substances, or are used in an exempted application, in accordance with EU Directive 2011/65/EC (RoHS2), as implemented March, 2013. RoHS Declarations for this product can be obtained from the Product Documentation sections of www.gptechgroup.com.

REACH Compliance

REACH substances of high concern (SVHCs) information is available for this product. Since the European Chemical Agency (ECHA) has published notice of their intent to frequently revise the SVHC listing for the foreseeable future, please contact our office at GPTG Headquarters in Lake Forest, California to insure you get the most up-to-date REACH SVHC Declaration. REACH banned substance information (REACH Article 67) is also available upon request.

This product has not been designed or tested for use in, and is not intended for use in, applications implanted into the human body nor in applications in which failure of the product could lead to death, personal injury or property damage, including but not limited to equipment used in the operation of nuclear facilities, life-support machines, cardiac defibrillators or similar emergency medical equipment, aircraft navigation or communication or control systems, or air traffic control.

Global Power Technologies Group Inc., Reserves the right to make changes to the product specifications and data in this document without notice.